

Installation & Use

Vienna Test System
Version 8.21 or higher



SCHUHFRIED

passion for psychology

CONTENTS

1	FOREWORD	3
1.1	Intended Use.....	4
2	THE WORKSTATION – ERGONOMICS	5
3	INSTALLING THE VIENNA TEST SYSTEM	7
3.1	Connecting the hardware	7
3.2	Software dongle – Getting the fingerprint.....	9
3.3	Installing the Vienna Test System	10
3.4	Installing the Vienna Test System – Clients.....	24
3.5	Updating the Vienna Test System.....	33
3.6	License installation	33
3.7	Uninstalling the VTS:	36
3.8	The control monitor	37
3.9	Encrypted communication in VTS (HTTPS).....	38
3.10	Manual adjustments to the system after the installation	44
3.11	Notes on backing up the database and restoring the VTS System.....	44
3.12	Setting up TestPlayer Web with a reverse proxy via IIS	45
4	DESCRIPTION OF PERIPHERAL DEVICES	49
4.1	Test system dongle.....	49
4.2	Response panels	50
4.3	Foot Pedals.....	53
4.4	Analog Foot Pedals	54
4.5	MLS Work Panel	55
4.6	Flicker fusion unit.....	56
4.7	Peripheral Perception 2 (PP-HW2)	57
5	HELP	62
5.1	Vienna Test System help functions	62
5.2	Manuals.....	64
5.3	Customer service.....	65
5.4	Hardware Test	67
6	ADDITIONAL INFORMATION	73
6.1	Warnings.....	73
6.2	Device maintenance	74
6.3	Safety information.....	74
6.4	Exclusion of liability.....	75
6.5	Packaging and transport.....	75
6.6	Guidelines and manufacturer’s declaration for EMC compatible construction in health facilities....	76

Release Revision G (date): 2022-04-02

1 FOREWORD

The Vienna Test System is the result of 25 years' experience in computerized psychological assessment. It comprises a wide selection of modern personality and ability tests, in forms which are continuously maintained and updated. The range of available tests is constantly being expanded – in addition to tests based on classical test theory, an increasing number of adaptive and multimedia tests are being developed to incorporate the benefits of innovative technologies and “modern” test theory.

The Vienna Test System is simple to use and requires no prior computer knowledge. The programs are clearly structured, enabling you to administer tests, evaluate the results and manage data very easily. Test results can be exported automatically into your reports, assessments and other documents. Queries can be quickly resolved with the aid of the comprehensive Help system.

The development and production guidelines which have been drawn up as part of our quality management system ensure that our products are durable, highly reliable and fault-free. We are continually improving both the expertise of our staff and the quality of our products.

Please follow these installation instructions carefully. If you need help, our HelpDesk staff will be happy to assist you:

E-mail: support@schuhfried.com

Telephone: + 43 2236 42315–460

Fax: + 43 2236 46597

We hope you will enjoy using the Vienna Test System!

1.1 Intended Use

The Vienna Test System is SCHUHFRIED's software system for computerized psychological assessment. It is used to test or assess individuals in the areas of personnel selection and development, clinical neuropsychology, traffic psychology and sports psychology.

The tests in the Vienna Test System are wide-ranging and include intelligence test batteries, special intelligence tests, ability tests, personality tests and attitude and interest tests. Some of the tests are based on "classical test theory" and others on "modern test theory". There are adaptive and multimedia tests. The tests help ensure that analysis of an individual's psychological status is as comprehensive, objective and valid as possible and also support effective planning of training and interventions.

2 THE WORKSTATION – ERGONOMICS

Desk and chair

The desk and the seat height of the chair must be adjusted so that the respondent can sit in an upright position while working the tests. The angle at which the screen is viewed should be about 30°. The foot pedals must be positioned so that they can be operated in a normal sitting position.

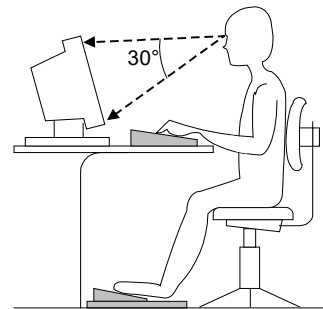

Optimum height of the work desk.

Lighting

The workplace should be lit by natural light. It must also be equipped with adequate artificial light which is set up to ensure an appropriate degree of contrast between the computer screen and the rest of the work environment.

The monitor should be positioned so that the user's direction of gaze is parallel to the line of the windows. The lighting should not cause glare or reflections in the monitor. If physical circumstances prevent the monitor being "ideally" positioned, other appropriate steps must be taken to avoid reflections and glare.

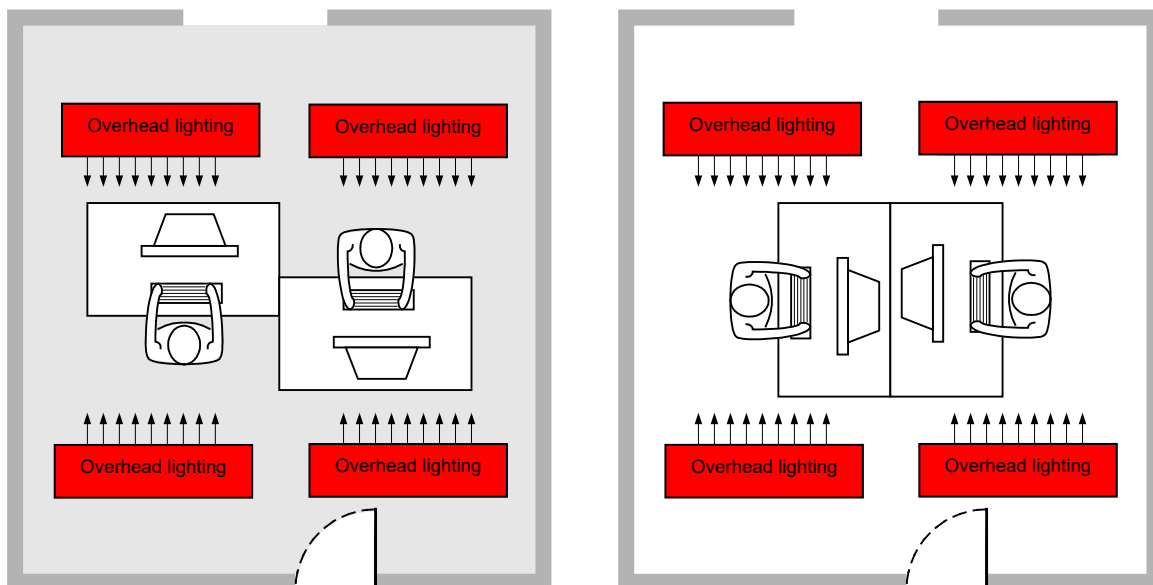

Figure 1: Incorrect (left) and correct (right) positioning of the workstation.

Noise

It is important that testing is not affected by noise. Taking into consideration sounds which intrude from outside, the noise level should not exceed 50 dB(A).

Temperature

The room temperature at the workstations must be between 19° and 25° C. The air speed must not be more than 0.1 m/s. The air humidity should be between 30% and 70% or between 40% and 70% if air conditioning is used.

Breaks

The test administrator is responsible for deciding on the timing of breaks; this should take account of candidates' needs. In test batteries breaks can be inserted between individual tests using the PAUSE program module.

3 INSTALLING THE VIENNA TEST SYSTEM

On account of the way in which Windows functions, these steps must be followed exactly.

Install the Vienna Test System before connecting the USB device.

In the event of queries relating to installation, please telephone our help desk (see Section 5.3).

3.1 Connecting the hardware

- a. Unpack the VTS hardware and have it to hand. Check whether your computer has the required number of free USB ports; if not, a powered USB hub will be needed.
- b. Turn on the computer and insert the USB stick with the installation software, if you have one, into a free USB port. If you do not have a USB stick, download the setup using the link in your e-mail. **Install the Vienna Test System first.** The drivers will be installed automatically during this process. **If you have a license dongle, insert it into another free USB port.**
- c. The test system dongle, Response Panels, MLS work panel and flicker/fusion unit are USB devices. Connect the **first USB device** to the computer **after installation** as shown in Figure 2. Details of the individual peripheral devices and their cabling are given in chapter 4.
- d. The **Peripheral Perception 2** unit should be connected to one of the computer's free USB ports using a USB - cable. The assembly of the Peripheral Perception unit 2 is described in Section 4.7.
- e. Authorized USB headphones do not require installation of a driver.

Notes:

- If you have connected the USB device (license dongle) **before the installation**, you may need to remove and reinsert the device before it is recognized correctly.
- The **1947 port** must be accessible and not blocked. For communication between the server and client (not relevant for individual workstation installation), additional ports **on the server and client must also be free**. These usually are: 7001, 7011, 7012, 7013, 7014, 7015, 7016, 7017, 7018.
- Microsoft® SQL Server Express is installed as part of the installation (refer to the system requirements for the exact version). If needed, the installation can be performed on an already installed SQL Server.
- Testing can be interrupted at any time by using the key combination **ESC + F5** or **ESC + E**. Please note that some tests **cannot** be continued once they have been interrupted in this way, because the test results could be influenced by learning effects if the test is re-started.
- The Vienna Test System can be set up in such a way that entry of user name and password is not required. In this case only one user and one multi-client can be created. If additional users are created, a login dialog appears, in which the required user can be selected.
- All EXE files of the Vienna Test System are certified. The validity of the underlying certificate is checked by the operating system by default when the computer is connected to a network. Should the computer not be connected to the Internet, this can

result in a long delay when starting the administration software or tests. This can be avoided by turning off the online certificate check via the Windows Control Panel.

- Remote installation with a HW dongle is not possible.

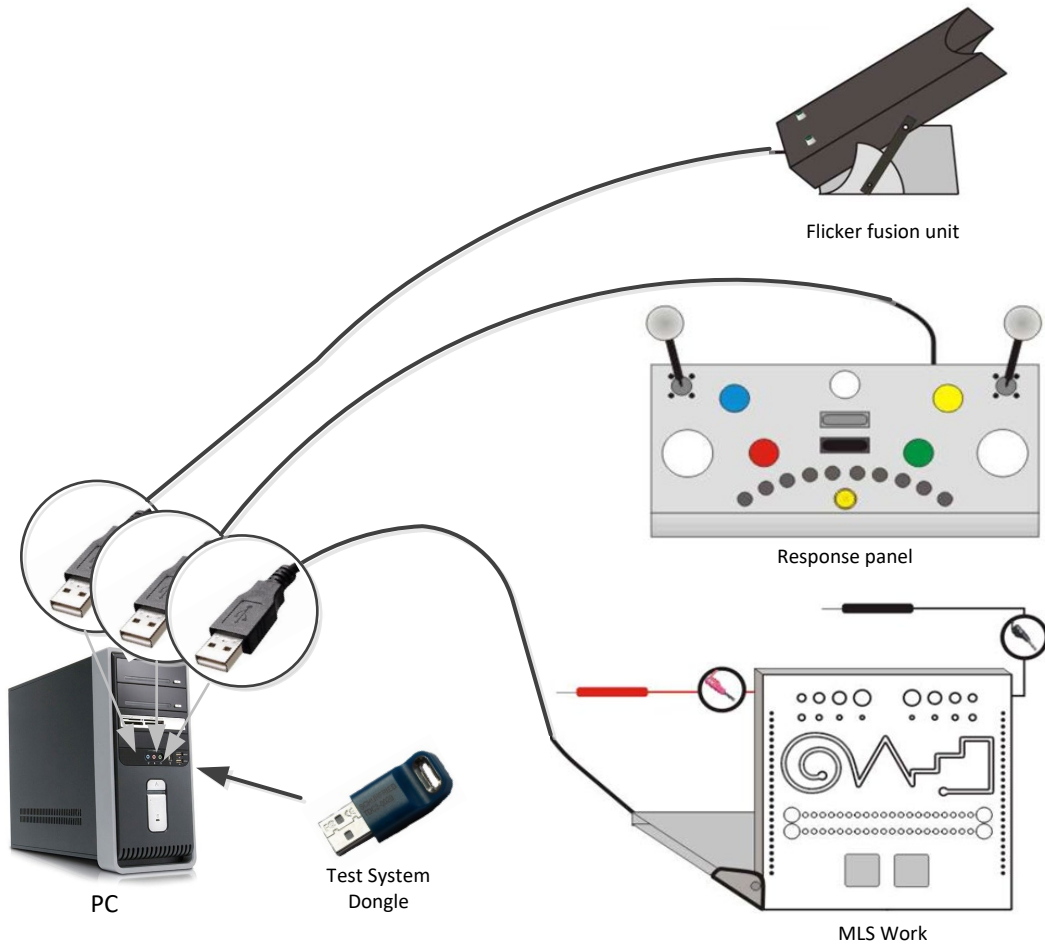

Figure 2: Connecting the USB devices to a PC

3.2 Software dongle – Getting the fingerprint

When a software license dongle is used, you must generate a fingerprint of the computer on which the Vienna Test System server is to be installed. The fingerprint must be generated **before** the Vienna Test System is installed. This fingerprint will be used by SCHUHFRIED to generate any Vienna Test System licenses that are ordered at a later date. The new licenses will then be sent to you separately.

To get the fingerprint please proceed as follows:

- Go to the “**Tools**” folder on the Vienna Test System DVD and copy the “**GetFingerprint**” folder to a local folder on the computer. The local folder must be one for which you have write permission.
- Launch the program “**GetFingerprint.exe**”.
- A file with the extension “**c2v**” will be created in the same folder.
- Send this file to info@schuhfried.com. Please quote the delivery note number in your email as this will speed up processing.
- Once the information has been processed you will receive an email with instructions on how to install the licenses. Please follow these instructions. The process is also described in Section [3.6](#).

Please note: it is essential that the fingerprint is generated on the computer on which the Vienna Test System server will be installed.

The software dongle measures hardware-dependent parameters of the computer on which it was generated. This also applies for specific properties of a virtual system. Moving the virtual system invalidates the software dongle and locks your Vienna Test System. For further details, please contact SCHUHFRIED Support (see Section [5.3](#)) **before changing the server**.

The following properties of the virtual system **must remain the same** for the software dongle to remain valid:

- Virtual MAC address
- CPU properties
- UUID (Universal Unique Identifier) of the virtual image; the UUID is generated by the virtualization software. If a clone is created, a new UUID is generated.

3.3 Installing the Vienna Test System

Before starting the installation ensure that all important updates for your version of Windows version are installed.

Therefore, you should perform a restart before the installation!

Also, before starting the installation of the update, be sure to backup all edited configuration files for your VTS, since all custom changes will be overwritten!

**E.g. the config file WTSService.exe.config that can be found in
C:\Program Files (x86)\SCHUHFRIED GmbH\Vienna Test System 8\Service
Or the config file appsettings.json that can be found in
C:\Program Files (x86)\SCHUHFRIED GmbH\TestPlayerWeb**

After an update has been installed, the backup config files shall be saved to those paths again for the custom changes to be taken into account.

If you want to install the VTS server, the VTS dongle must be inserted into the server and not into a workstation. When using a software dongle, it must be installed before installing the VTS server.

For this setup, the AdminClient and Testplayer are installed automatically. If you want to install the Client setup, please refer directly to the chapter [Installation of the Vienna Test System – Clients](#)

1. Start up your PC and log in as a user with local administrator rights.
2. Should you not have a USB stick with the setup, download the setup via the link in your e-mail. The setup is approx. 5 GB and provided in a ZIP file. Save the file to the PC on which you want to install the Vienna Test System and unzip the file.

Start the installation and double-click on the file "**Wts8Setup.exe**" and then keep reading from point 5 on.

3. Should you have a USB stick with the setup, insert the USB stick into a USB port of your computer to install the Vienna Test System.
4. Go to My Computer ("Computer" in Windows 7). Double-click on the symbol for the USB stick. **Double-click on the file "Wts8Setup.exe"** to start the Setup program.

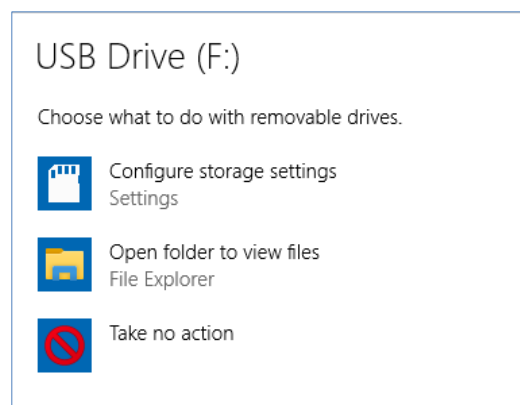

- A Windows confirmation prompt appears.

Confirm the security request with “Yes”.

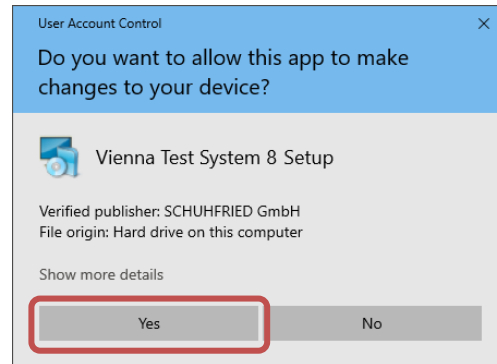

- Accept the license agreement.

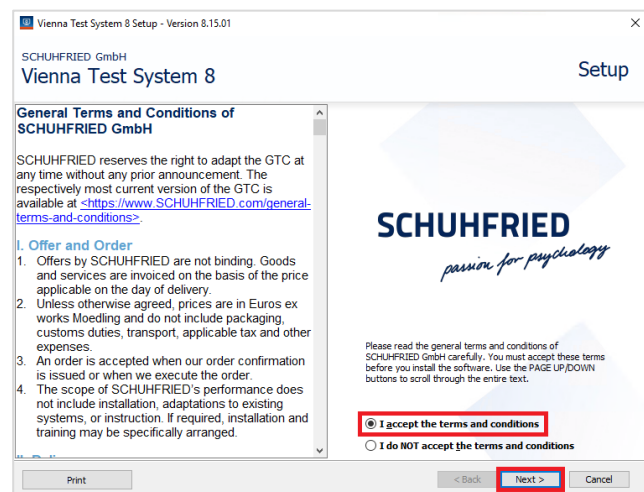

- The installation of the Vienna Test System (both as a server/client and individual workstation installation) starts now. You can now choose between the standard installation and the user-defined installation. If you choose the standard installation, please continue reading from point 10 on.

Click “Next >” to continue.

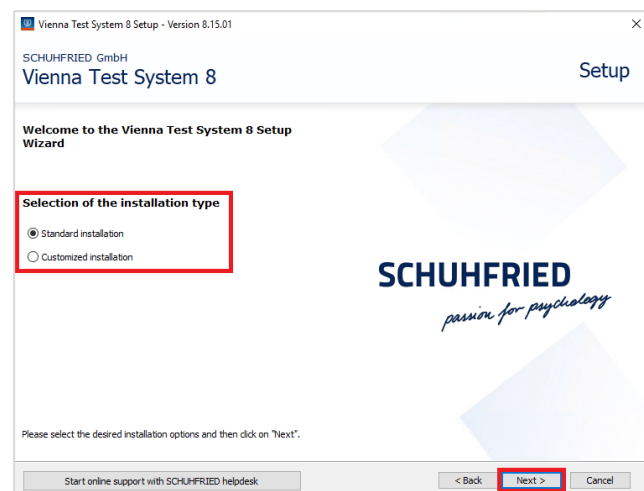

- At this stage you can decide whether to install Microsoft® SQL Server Express 2016 2016 Service Pack 2 (keep reading from point 10 on) or if an already installed SQL Server should be used (see point 9).

After making your choice, click **“Next>”** to continue.



- If you want to use the Vienna Test System SQL - database on an existing SQL - server, you must enter the **server name** and **catalog name**.

You can get the necessary details from your SQL - administrator. **Click “Next >” to continue.**

The database must be selected before the installation via scripts. See section [3.3.1](#) for further information. In this case the option "Database was already added and updated" must be selected.

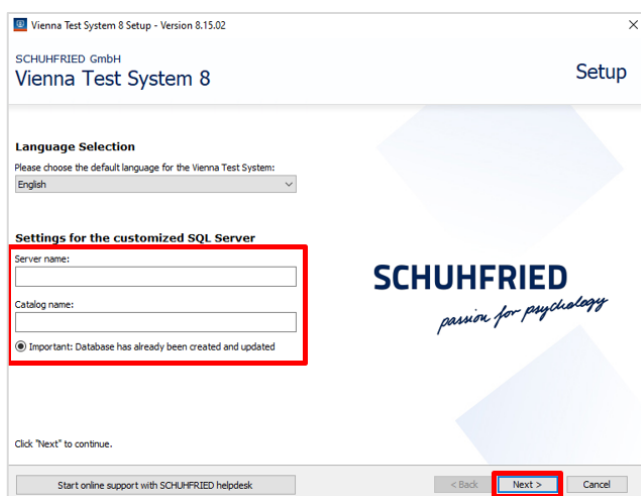

- The setup program now checks which programs need to be installed. After testing, the program list is displayed. (Please do not make any changes to this list!) The programs listed will depend on your operating system and the programs currently installed.

Click “Next >” to continue.

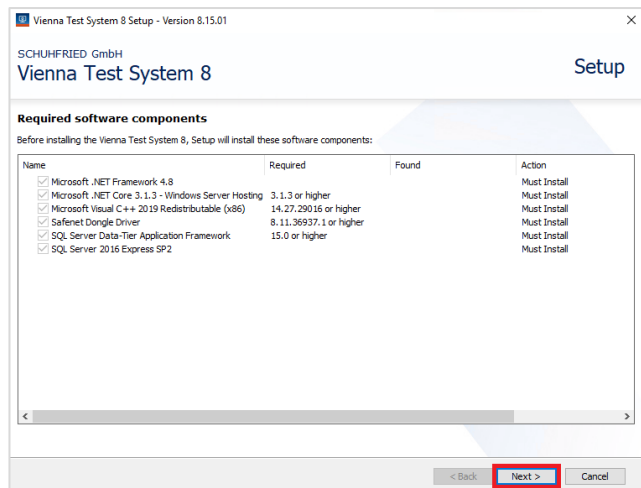

11. Now select the desired language.

Click “Next >” to continue.

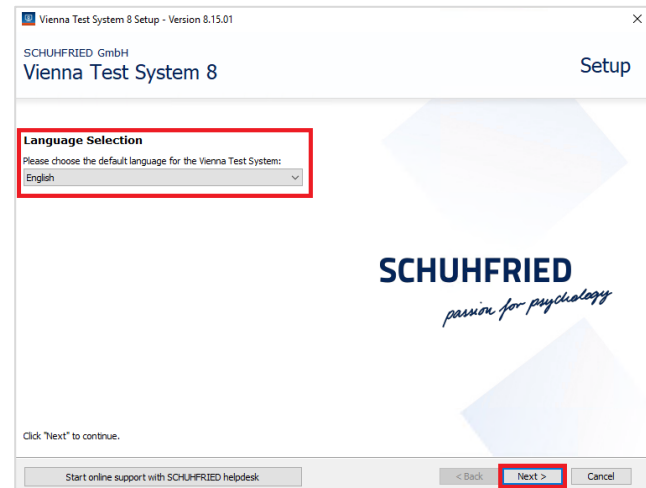

12. Now define the test system administrator’s user name and password. This user will then be available on all clients. The VTS setup program suggests the user name “Admin”. The user name chosen:

- must not start or finish with a space.
- may only contain the characters A-Z, a-z, 0-9 as well as the special characters !"#\$%!*+-=?^_~

Enter a password of your choice in the “Password” field and re-enter it under “Re-enter password”.

The selected password must be at least 8 characters long and may only include the following characters: A-Z, a-z, 0-9 as well as the special characters !"#\$%!*+-=?^_~.

If **no password** is required, the option “No password needed to log in to the test system” can be selected. The Vienna Test System then starts without a user prompt. We would like to point out that in this case other suitable technical and organizational measures must be taken to ensure the safety of personal data as stipulated by GDPR.

Click “Next >” to continue.

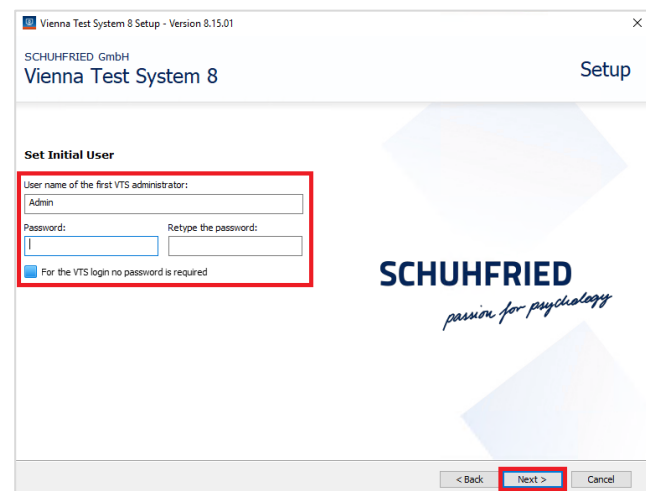

Make a note of the test system administrator’s user name and password.

You will not be able to access the Vienna Test System without these details!

13. If at this point no VTS license dongle has been inserted (or is to be installed with a product key), you can choose the type of dongle in the next step. Choose your type of dongle and confirm with **"Next >"**.

Should the license dongle not be inserted, you will be asked to do so.

Please note that in the case of a product key you need an Internet connection during the installation.

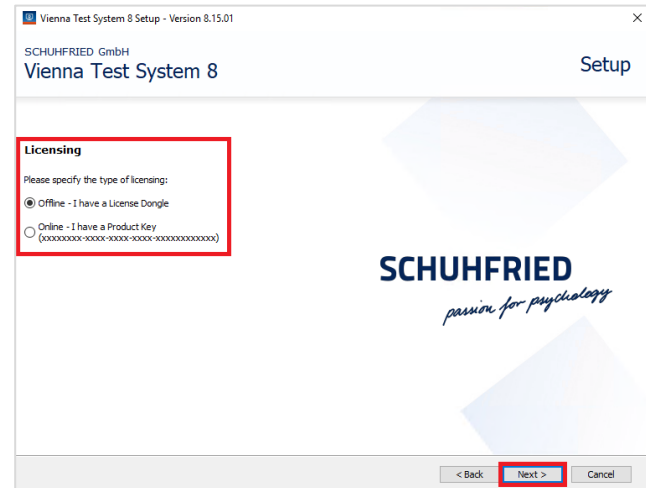

14. If you own a product key, please enter it into the field that appears below, confirm with **"Next>"** and keep reading from point 15 on.

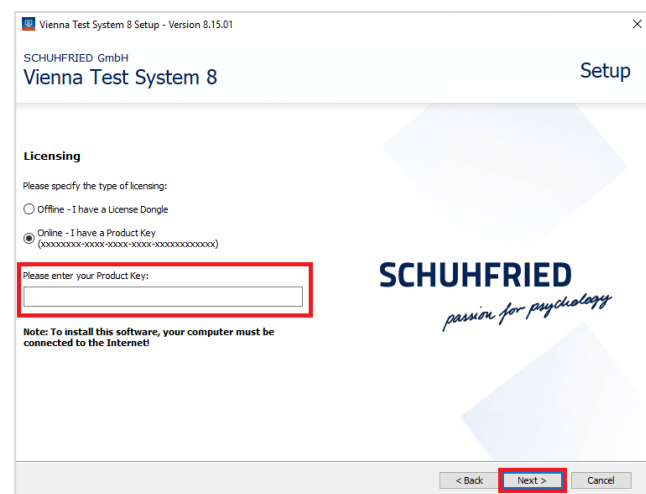

15. You now need to specify whether:
- the Vienna Test System license dongle (software or dongle) exists on the computer on which the Vienna Test System server is being installed (option **"License dongle on this computer"**)
 - or if it exists on another computer on the network (option **"License server on the network"**).
If there is a license server, the name of the computer or its IP address must be entered in the box below. Click on "Update license list" once you have entered the address and select the dongle.

If more than one multi-client is available, you can choose which

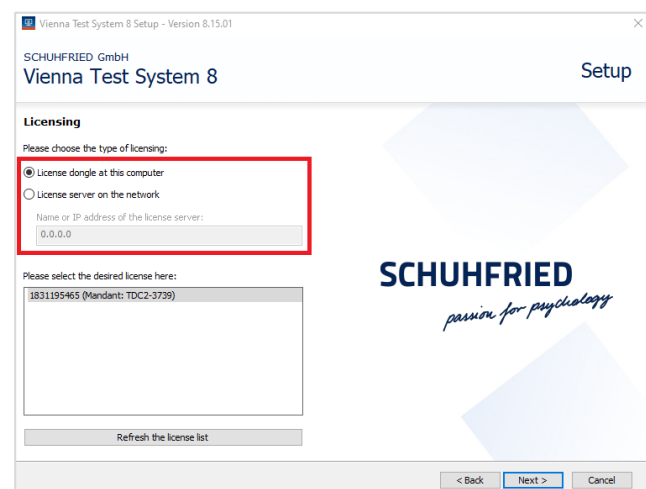

one to use for this Vienna Test System server installation.

Click “Next >” to continue.

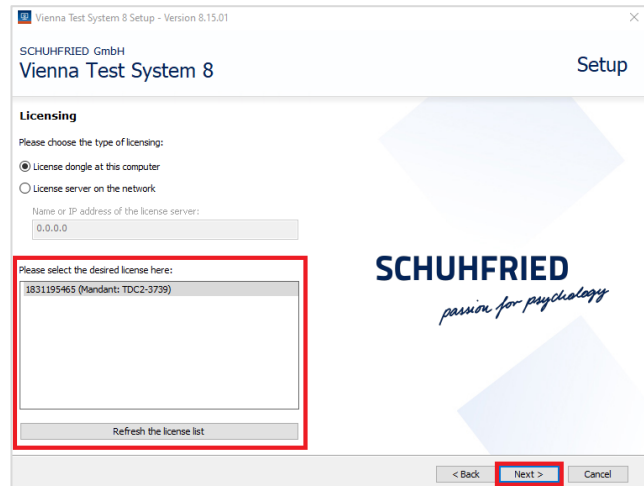

16. The next installation dialog shows the details needed to connect the clients. You will need to quote these details to set up the Vienna Test System clients.

Note them and keep them carefully. They will be needed to install all the Vienna Test System clients.

Under “Customized Server Settings” you can define which ports the VTS server and VTS clients will use to communicate with each other

The ports specified here must be open for client access.

When all the settings have been made, click “Install”.

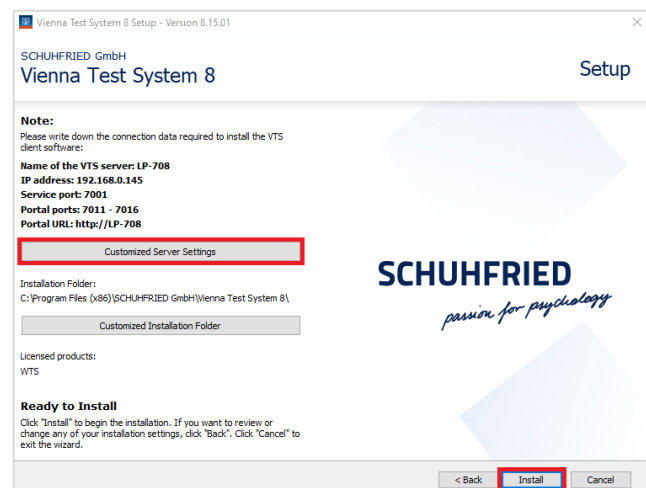

17. The installation of the Vienna Test System is now executed. This may take a few minutes.

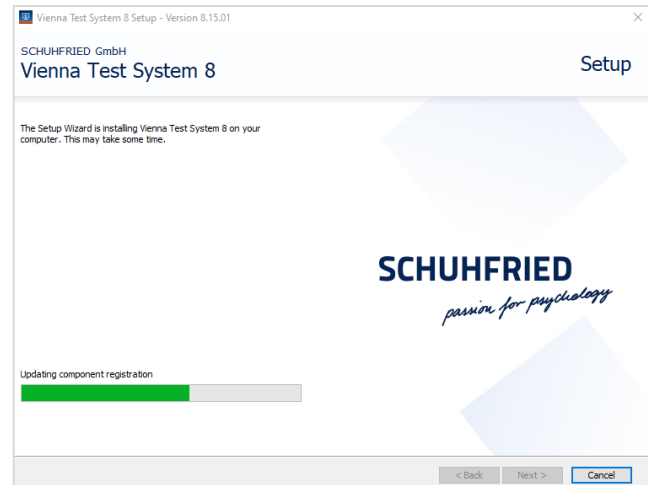

18. When the installation is completed, this window appears.

Finally, click "OK".

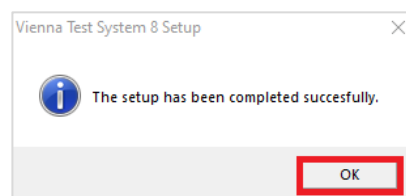

ATTENTION:

To test whether the VTS has been successfully installed, you can check whether the "VTS service" has been launched. In this case, the AdminClient and Testplayer can be started via shortcuts on the desktop.

If you purchased peripheral devices, please run the **Hardware test** now (see chapter 5.4, picture 18) to ensure that all devices have been installed successfully.

3.3.1 Installing the server with scripts

This point must **only** be carried out **for a first-time installation** if the VTS should be installed with **your own SQL Server via scripts**. When the installation is carried out completely via the setup, this point is not necessary.

In order to carry out the installation of the VTS database via scripts, the following must be in place:

- SQL Server (refer to the system requirements for the exact version)
- SQL Server login with sufficient rights to add an additional login

Before the installation with scripts can be carried out, a "wtsnx" login must be added in the planned database instance. This is absolutely necessary for the installation. You can obtain the password for the login from technical support.

Adding the "wtsnx" login with Microsoft SQL Server Management Studio:
 Connect to the corresponding SQL server instance and add a new login with the name "wtsnx" under "Security\Logins". The following properties must be adapted on the "General" tab for this purpose (see Figure 3):

- Login name: wtsnx
- Login type: SQL Server authentication
- Password: Contact technical support
- Enforce password policy: Deactivate

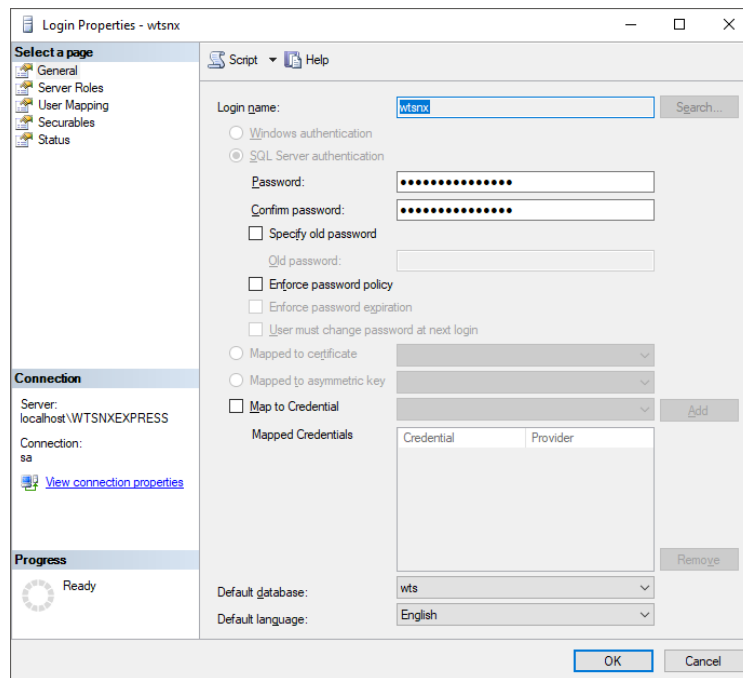

Figure 3: Settings for the login in Microsoft SQL Server Management Studio

Generating the databases for the installation of the Vienna Test System:

The Vienna Test System uses multiple databases for different types of data. The "WTS" database contains candidate and test data, the "DTC" database is used for the web interface and the associated web functionalities, and the "WTSKatalog" database includes the metadata on tests and test sets.

1. WTS Database:

The scripts available must be processed exactly in the following order:

- wts_1_create_database_v8.X.X.sql¹
- wts_2_create_tables_v8.X.X.sql
- wts_3_insert_data_v8.X.X.sql
- wts_4_optimize_database_v8.X.X.sql

The scripts are stored in the setup folder in the directory "**Scripts\First Installation**". Be sure to follow the instructions below!

¹ "V8.X.X.sql" stands for the version. For version 8.15.01, for example, the files are called "wts_1_create_database_V8.15.1.sql".

The database is created by the scripts with the VTS default collation "Latin1_General_CI_AS".

Execution of the scripts:

- Scripts 1, 2, and 4 can generally be run from within MS SQL Server Management Studio.
- It is **not recommended to run script 3** from the MS SQL Server Management Studio because the script is very large and can cause an "OutOfMemory" exception. It is therefore recommended to run the script command line via "sqlcmd". This must be carried out with the following parameters²:
 - sqlcmd -S <NameorIPofSQLServer>\<InstanceName> -U sa
-P <password> -i <path to script & scriptname.sql>

Example for the instance "wtsnexpresss" under localhost with the user sa and the password 1234. The scripts are stored under "C:\temp\".

```
sqlcmd -S localhost\wtsnexpress
-U sa
-P 1234
-i C:\temp\wts_3_insert_data_v8.15.1.sql
```

2. DTC Database:

The available scripts must be processed exactly in the following order:

- dtc_1_create_database_v8.X.X.sql
- dtc_2_create_tables_v8.X.X.sql

The scripts are stored in the setup folder in the directory "**Scripts\First Installation**".

3. WTSKatalog database

Adhere to the following order for this database:

- In MS SQL Server Management Studio: right-click Databases and select the item "Attach...".
- Click "Add" button and select the file "WTSKatalog.mdf".
- **Important:** Enter the name "WTSKatalog" into the "Attach As" column field if necessary.
- **Important:** Change the file path under "Current File Path" column field to the .mdf and .ldf file within the extracted folder.
- Then run the script "productdb_1_update_schema_v8.X.X.sql" on the "WTSKatalog" database.

The scripts and .mdf file are stored in the setup folder in the directory "**Scripts\First Installation**".

Updating the databases with scripts:

This step is **only necessary** when the **databases of the Vienna Test System should be updated via scripts instead of the setup**.

Furthermore, the password of the SQL login "wtsnx" should be updated to the latest version, see item 3.3.1.

² The correct installation can only be guaranteed with the user "sa".

1. WTS Database:

The following scripts must be processed exactly in the following order:

- wts_1_update_schema_v8.X.X.sql
- wts_2_update_data_v8.X.X.sql
- wts_3_optimize_database_v8.X.X.sql

The scripts are stored in the setup folder in the directory "**Scripts\Update Installation**". All three scripts can be processed from within MS SQL Server Management Studio.

2. DTC Database:

The following script must be processed:

- dtc_1_update_schema_v8.X.X.sql

The script is stored in the directory "Scripts\Update Installation".

3. WTSKatalog database

Adhere to the following steps:

- Delete the existing "WTSKatalog" database from your SQL Server.
- In MS SQL Server Management Studio: right-click Databases and select the item "Attach...".
- Click "Add" button and select the file "WTSKatalog.mdf".
- **Important:** Enter the name "WTSKatalog" into the "Attach As" column field if necessary.
- **Important:** Change the file path under "Current File Path" column field to the .mdf and .ldf file within the extracted folder.
- Then run the script "productdb_1_update_schema_v8.X.X.sql" on the "WTSKatalog" database.

The scripts and .mdf file are stored in the setup folder in the directory "**Scripts\Update Installation**".

3.3.2 Notes on installation

After installation, the Vienna Test System can be launched using the details entered under "**Default user name**" and "**Password**". This user has full administration rights in the Vienna Test System. He/she can therefore register new users and define their permissions.

The user added during the installation is automatically at the highest security level (security level 0). This user can therefore change all settings in the Vienna Test System or add new users.

Note:

There must be at least one user who is at the highest security level. Otherwise, the Vienna Test System can no longer be managed.

The following security levels are available:

Security level	Authorization
0	This security level permits access to all the functions of the test system.

1	No settings can be changed at this security level. Therefore, no test batteries can be created or changed, no basic settings (e.g. folders for data storage) can be made and no tests can be installed. However, the Vienna Test System, can be used and there is unrestricted access to the databases.
2	At this security level the test system can be used only to administer and score tests; access to all other functions is barred. The test results can only be accessed with limitation to the extent that only the data sets stored during test presentation can be scored after the test presentation. Other test results cannot be accessed.
3	At this security level the test system can be used only for test presentation. Access to all other functions and to the database is completely barred.

The applications of the Vienna Test System are signed. The signature is checked by default on Windows operating systems through a server. This check takes place when Windows detects a network. If communication to the Internet is blocked by network settings, this can lead to significant delays when starting the Vienna Test System or when starting tests. In this case, it is recommended to switch off the signature check.

3.3.3 Individual workplace installation via Command Line

The Vienna Test System can also be installed silently via parameters. The call is defined as follows:

```
Wts8Setup.exe /qx DEFAULT_CULTURE="de-DE"
              AC_USERNAME_PROP="Admin" AC_PASSWORD_PROP="xxx"
```

Other optional parameters:

```
PRODUCT_KEY="XXXX"
LICENSE_FILE="c:\TEMP\W12345_001_01_ID21_31001_Lizenz.v2c"
APPDIR="C:\Program Files\Wiener Testsystem 8"
ICON_TP="1"
/L*V „%temp%\WTS8Silent.log"
```

Explanations:

Parameter	Value	Description
/qx	qr	No user input with installation progress indicator
	qb	No user input with installation progress indicator as progress bar
	qn	No user input and no installation progress indicator
DEFAULT_CULTURE	de-DE	Compulsory parameter for initial installation
	en-US	Defines the language of the Admin Console and the
	...	Testplayer This must always be specified. The language of the interface can be changed later if required.
AC_USERNAME_PROP	Text	Compulsory parameter for initial installation Defines the first login for the Vienna Test System..

AC_PASSWORD_PROP	Text	Defines the password for the login specified above. Unless NO_AC_PASSWORD is stated, this parameter must be used.
NO_AC_PASSWORD	1	If the parameter is set to 1, no password is needed for login. This is not recommended! If a password is used, this parameter is not necessary.
PRODUCT_KEY	Text	Indication of the product key if a software dongle is installed with it.
LICENSE_FILE	Text	Defines the path for a v2c license file, if this is to be entered during installation. This is not necessary during first installation.
APPDIR	Path	This defines the path for installation of the Vienna Test System. If nothing is specified, the program is installed in the folder "C:\Programs (x86)\Schuhfried GmbH\Wiener Testsystem 8".
ICON_TP	1	If this parameter is set, an icon for Direct Testing is placed on the desktop and in the start menu.
/L*V	Text	If this parameter is used, a log file of the installation is created in the specified file (complete path).
/exelang	1031 1033	Starts the setup in German (optional). Starts the setup in English (optional).
WTS_PORTAL_URL	Text	Defines the address to reach the VTS Portal. This value should be the domain name or the computer name (default = computer name)
WTS_SERVICE_PORT	7001	Determines the port for the VTS service. Here, a free port in the range from 7001 to 7999 must be specified that the VTS clients use to communicate with the VTS service on the server. This parameter shall not be omitted.
WTS_PORTAL_PORT	7011	Determines the base port for the VTS portal. Here, a free port in the range 7001 to 7999 must be specified. Please note that five additional ports can be assigned in sequence. This specification is optional (default=7011).
LICENSE_SERVER_ID	Text	Determines the IP address or the name of the dongle server (only to be specified when the dongle is inserted into your own license server. Default="localhost")
DB_SERVER_INSTANCE	Text	Determines the server name of the SQL server (must only be specified when a user-defined SQL server should be used).
DB_CATALOG_NAME	Text	Determines the catalog name of the SQL server (must only be specified when a user-defined SQL server should be used).
SQL_SA_USER	Text	Determines the login name of the SQL server system administrator (only when a user-defined SQL server is used and the sa user can be provided).
SQL_SA_PASSWORD	Text	Determines the password of the SQL server system administrator (only when a user-defined SQL server is used and the sa password can be provided).

MANDANT_ID	Text	This parameter can be used to set the multi-client with which the Testplayer should start (e.g. W12345_001). If "AUTO" is entered, the first multi-client found on the server will be selected. If the multi-client should be entered for every start, MANDANT_ID="-" should be entered.
CERTIFICATE_FILEPATH	Text	Use this parameter to specify the file path to a personal certificate used for communicating between the components.
CERTIFICATE_PASSWORD	Text	If CERTIFICATE_FILEPATH is set, you can specify the password of the personal certificate with this parameter.
CERTIFICATE_SUBJECT	Text	If CERTIFICATE_FILEPATH is set, you must specify the subject (or the domain) of the personal certificate with this parameter.

Examples:

Installation in English with log file:

```
WTS8setup.exe /qr DEFAULT_CULTURE="en-US" AC_USERNAME_PROP="admin"
AC_PASSWORD_PROP="admin" /L*V „%temp%\WTS8Silent.log"
WTS_SERVICE_PORT="7001"
```

Installation in German with Direct Testing icon on the desktop and no password:

```
WTS8setup.exe /qr DEFAULT_CULTURE="de-DE" AC_USERNAME_PROP="admin"
NO_AC_PASSWORD="1" ICON_TP="1" WTS_SERVICE_PORT="7001"
```

Installation with product key

```
WTS8setup.exe /qr DEFAULT_CULTURE="de-DE" AC_USERNAME_PROP="admin"
AC_PASSWORD_PROP="Admin123" PRODUCT_KEY="xxx-xxx-xxx-xxx-xxx"
WTS_SERVICE_PORT="7001"
```

Installation with a personal certificate

```
WTS8setup.exe /qn DEFAULT_CULTURE="en-US" AC_USERNAME_PROP="admin"
AC_PASSWORD_PROP="Admin123" WTS_SERVICE_PORT="7001"
CERTIFICATE_FILEPATH="<path>\certificate.pfx"
CERTIFICATE_PASSWORD="MyCertPwd"
CERTIFICATE_SUBJECT="www.schuhfried.com"
```

Notes:

- The parameters **AC_USERNAME_PROP**, **AC_PASSWORD_PROP** and **NO_AC_PASSWORD** are only needed during initial installation. In the event of an update, the information they contain is ignored.
- The parameters **DB_SERVER_INSTANCE** and **DB_CATALOG_NAME** must only be specified when a user-defined SQL server should be used. When they are not specified, the SQL Server Express is installed and used as the database. When **DB_SERVER_INSTANCE** is specified, the installation of the SQL Server Express as a prerequisite is skipped automatically.
- The parameters **SQL_SA_USER** and **SQL_SA_PASSWORD** must only be specified when a user-defined SQL Server should be used. When they are not provided, the

database must have already been created or updated before running the setup since the setup cannot create or update the database without the sa user.

- If no dongle (hardware or software dongle) is found and the **parameter PRODUCT_KEY** is used, the program tries to create a software dongle. This requires an **internet connection**. If a dongle is present, any value quoted after PRODUCT_KEY is ignored.
- Double quotation marks (") around the parameter values are only needed if the value contains spaces (e.g. in a path or file name).
- If a parameter is included, it **must contain a value**. Empty values (e.g. AC_PASSWORD_PROP="" or AC_PASSWORD_PROP=) are not permitted and result in installation errors.
- The parameter /exelang must be at first place, if specified. There must always be a space before the language ID (1031 or 1033). /exelang=1031 does not work.
- The parameter /exenoui is no longer supported by the current installer and is ignored. Prerequisites are now always installed without a user interface.

The following languages are available in the Admin Console:

Language	Language code
Chinese – Simplified	zh-CN
German	de-DE
English (USA)	en-US
French	fr-FR
Italian	it-IT
Dutch	nl-NL
Polish	pl-PL
Portuguese	pt-PT

Language	Language code
Romanian	ro-RO
Russian	ru-RU
Swedish	sv-SE
Slovak	sk-SK
Slovene	sl-SI
Spanish	es-ES
Czech	cs-CZ
Turkish	tr-TR

3.4 Installing the Vienna Test System – Clients

Before starting the installation ensure that all important updates for your version of Windows version are installed.

Therefore, you should perform a restart before the installation!

Also, before starting the installation of the update, be sure to backup all edited configuration files for your VTS, since all custom changes will be overwritten.

This section describes the installation of the Vienna Test System clients. There are three programs that can access the Vienna Test System server:

- **VTS – Testplayer:** You can use this module to administer previously saved test batteries and tests at a workstation to respondents whose details are already in the system.
- **Administrator console:** Using this program you can configure the Vienna Test System, install new licenses, back up the database, enter the details of users and respondents, manage user and personal data, create test batteries, score completed tests, print and export test results and create Word reports.
- **Control monitor:** This program is used to monitor the operation of the Testplayer. It enables you to see which test is being worked by which person on which Testplayer.

1. Start up your PC and log in as a user with local administrator rights.
2. If you have purchased an online license, download the setup via the link in your e-mail. The setup is approx. 5 GB and provided in a ZIP file. Save the file to the PC on which you want to install the Vienna Test System and unzip the file.

Start the installation and double-click on the file "**Wts8Setup.exe**" and then keep reading from point 5 on.

3. Should you have a USB stick with the setup, insert it into a USB port of your computer to allow for the Vienna Test System installation.
4. Open My Computer (for Windows 7 "Computer) and double-click the symbol for the USB stick. **Double-click on the file "ClientSetup.exe"** in the "content" subfolder to start the setup program.

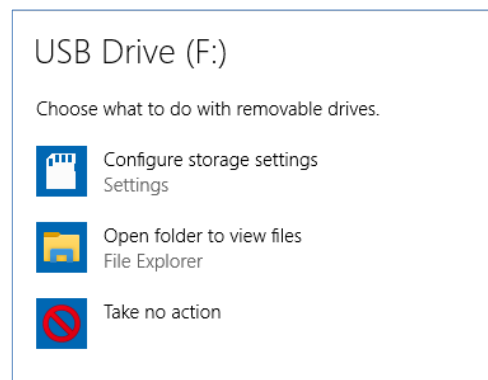

5. A Windows confirmation prompt appears.

Confirm the security request with “Yes”.

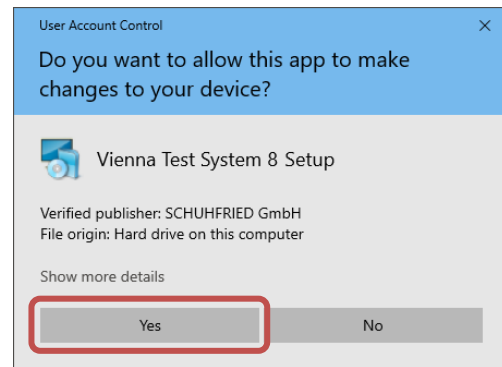

6. If the .NET Framework 4.8 is not yet installed, you will need to accept the end user license agreement. A list of the necessary programs appears. (Please do not make any changes to the program list!) Click “Next >” to continue. These two steps are omitted if the framework is already installed on the client PC.

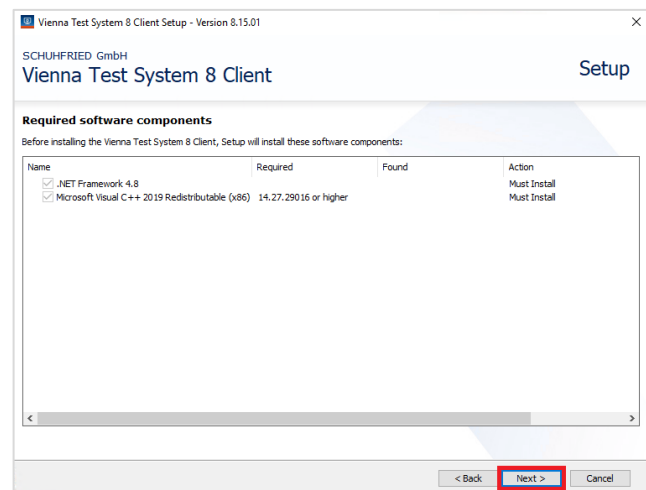

7. Next, the information needed for the connection to the VTS server must be entered. Enter the **name** (or IP address) of the server and the **port for the service**.

The format for the server address is:
<https://SERVERNAME:PORT>,
 e.g. <https://WTSSERV:7001>.

If a proxy server is used, click the check box "Communicate via a proxy server" and enter your configuration.

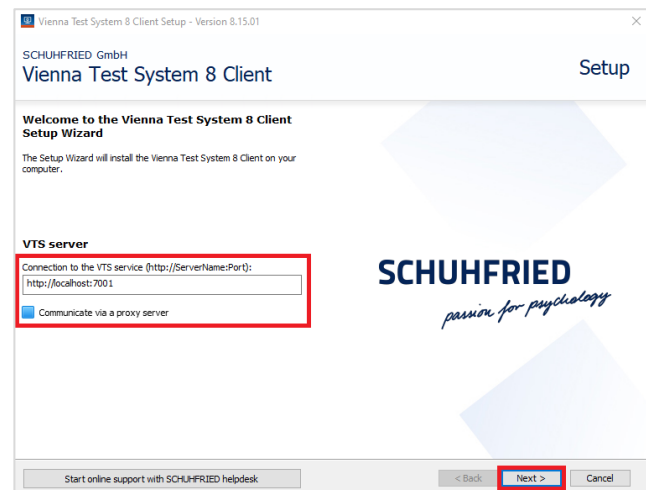

The ports to be used for communication must also be open on the clients.

Next, define which components are to be installed on the computer:

8. Here you can **install the VTS Testplayer** (for testing via Direct Testing).

Clicking "Next" brings up the following options:

- Default language: This language is independent of the test language
- Multi-client: Here you can specify whether one multi-client will always be used or whether a choice of multi-clients is to be offered each time the Testplayer is launched.
- Display test info on the VTS control monitor: Necessary if a control monitor is used. Specify the connection (address or name **and** port) to the PC where the control monitor is installed.
- Icons on desktop:
 - Testplayer for Direct Testing
 - Hardware test for checking the SCHUHFRIED hardware connected to the client

9. Here you can **install the VTS administration software**.

You can define the default language and decide whether an icon should be placed on the desktop.

The language of the administration software can be changed later if required. During installation the Testplayer will also be installed. This means that tests can be launched from the administration software , without installing the Testplayer separately.

Use this check box to specify whether an icon should be placed on the desktop.

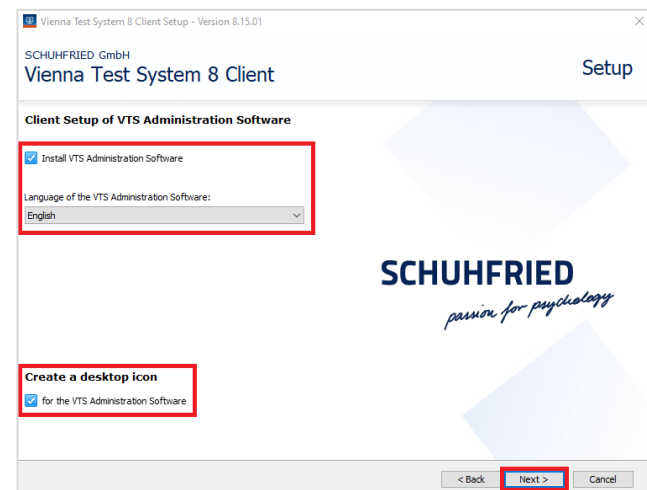
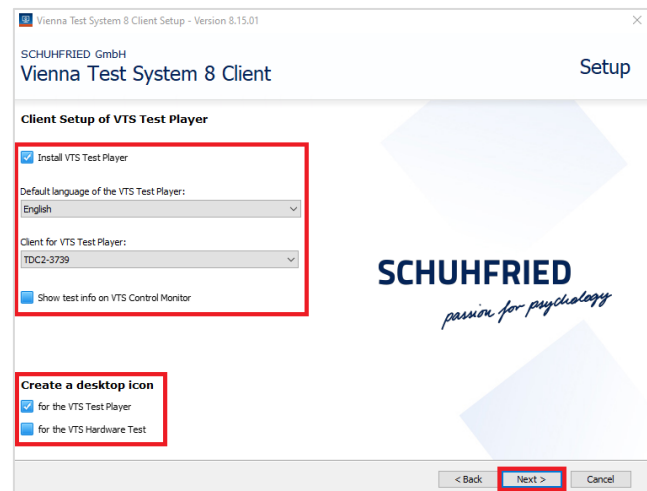
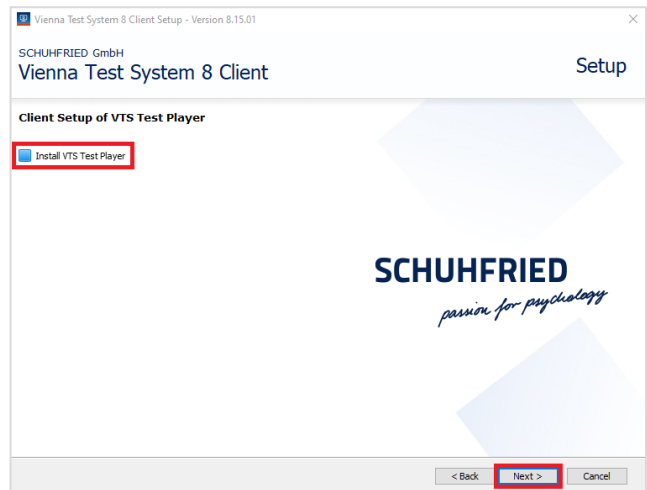

10. Here you can install the VTS control monitor.

You can define the default language and decide whether an icon should be placed on the desktop.

You should install the control monitor on the computer that will be used to monitor the test stations.

For information on configuring the control monitor see Section Uninstalling the VTS:3.7.

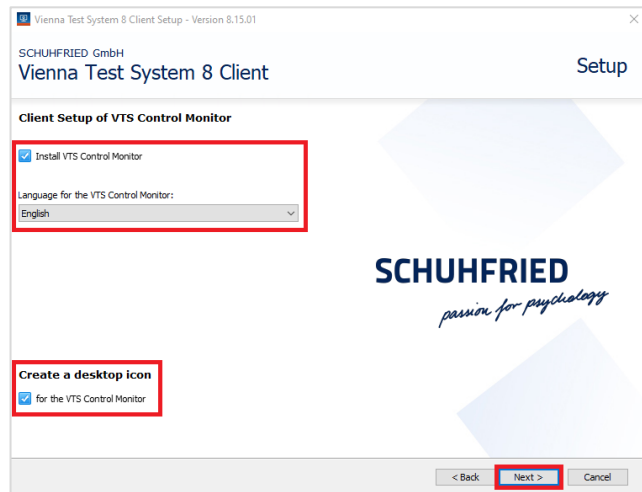

11. A summary of your settings is now displayed. Click “Install” to start the installation.

The system uses the abbreviations:

- TP: Testplayer
- AC: Administration software (including the divisions)
- CM: Control monitor

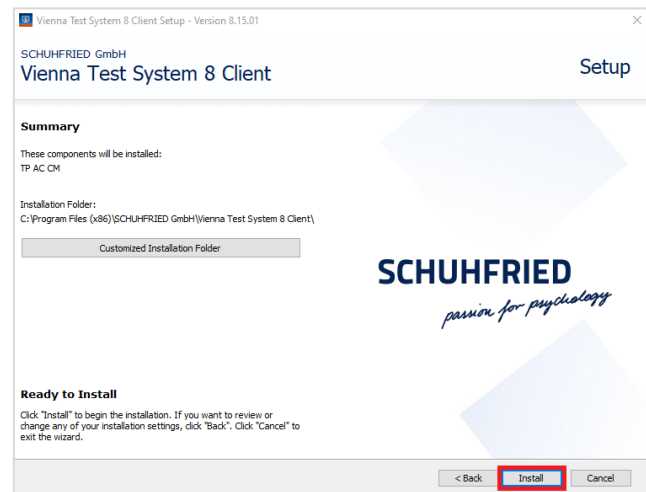

12. The installation is now performed.

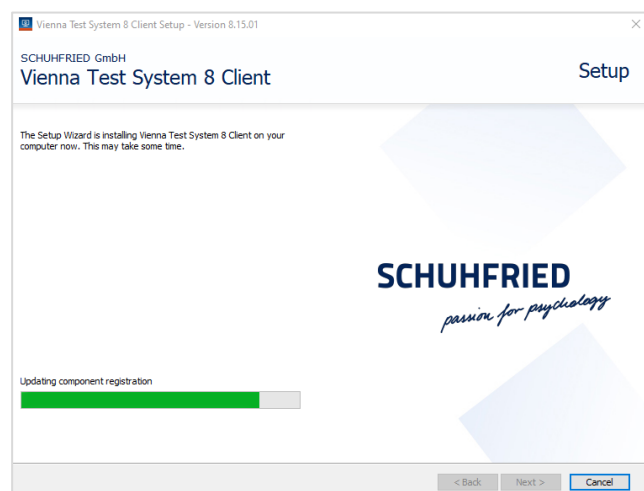

13. When the installation is completed, this window appears. **Finally, click “Finish”.**

Installation has now been completed. You will find entries on the desktop and in the start menu for starting the Vienna Test System



Icon for opening the **Vienna Test System administration software**

The icon will have an addition showing which of the special versions of the VTS is installed (HR, Neuro, Traffic, Sport).

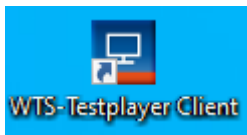

Icon for opening the **Testplayer for Direct Testing with the Vienna Test System**



Icon for opening the **Vienna Test System control monitor**

3.4.1 Notes on client installation

If you **only** install the administration software, you will not be able to start any tests; you cannot start any tests directly from the administration software either. The Testplayer **also** needs to be installed.

If you use a proxy server, Windows takes it from the global proxy settings.³

For the configuration of the **“Picture 2 Proof”** feature, the Testplayer must be started with the Parameter **“-c”** e.g.: "C:\Program Files (x86)\SCHUHFRIED GmbH\Wiener Testsystem 8 Client\TestPlayer\WTSTestplayer.exe -c".

3.4.2 Notes on installation

After installation the Vienna Test System , can be launched using the details entered under **“Default user name”** and **“Password”** when the VTS Server was installed. This user has full administration rights in the Vienna Test System. He/she can therefore register new users and define their permissions.

³ Only applies when the proxy server is between the computer on which the client installation is run and the computer on which the server is installed.

At least one user must be assigned the highest security level (0). Without a user at this security level no administrative tasks can be performed in the Vienna Test System.

The following security levels are available:

Security level	Authorization
0	This security level permits access to all the functions of the test system.
1	No settings can be changed at this security level. Therefore, no test batteries can be created or changed, no basic settings (e.g. folders for data storage) can be made and no tests can be installed. However, the Vienna Test System, can be used and there is unrestricted access to the databases.
2	At this security level the test system can be used only to administer and score tests. Access to all other functions is barred. The test results can only be accessed with limitation to the extent that only the data sets stored during test presentation can be scored after the test presentation. Other test results cannot be accessed.
3	At this security level the test system can be used only for test presentation. Access to all other functions and to the database is completely barred.

The applications of the Vienna Test System are signed. The signature is checked by default on Windows operating systems through a server. This check takes place when Windows detects a network. If communication to the Internet is blocked by network settings, this can lead to significant delays when starting the Vienna Test System or when starting tests.

In this case, it is recommended to switch off the signature check.

3.4.3 Installing the clients via command line

The clients (administration software (ADSW) and Testplayer (TP)) can also be installed via parameters and managed silently. The call is defined as follows:

```
ClientSetup.exe /qx
    INSTALL_AC=1 LANGUAGE_AC=de-DE
    INSTALL_TP=1 LANGUAGE_TP=de-DE MANDANT_ID=AUTO
    WTS_SERVICE_BASE_ADDRESS=https://XX.XX:7xxx
```

The parameters for the client setup are always set automatically and cannot be specified in the command line of the One setup:

```
INSTALL_TP=1
INSTALL_AC=1
INSTALL_CM=0
ICON_TP=1
ICON_AC=1
ICON_HWT=1
ICON_CM=0
WTS_SERVICE_BASE_ADDRESS=http://localhost:[WTS_SERVICE_PORT]
LANGUAGE_AC=[DEFAULT_CULTURE] LANGUAGE_TP=[DEFAULT_CULTURE]
MANDANT_ID=AUTO
```

If the automatically selected parameters do not fit, then `RUN_CLIENT_SETUP=0` should be used and the Client Setup should be called up separately with the desired parameters.

Explanations:

Parameter	Value	Description
/qx	qr	No user input with installation progress indicator
	qb	No user input with installation progress indicator as progress bar
	qn	No user input and no installation progress indicator
INSTALL_AC INSTALL_TP INSTALL_CM	1/0	When a parameter is set to "1", the administration software (AC), the Testplayer (TP) or the server of the control monitor (CM) is installed. When a parameter is set to "0", the corresponding package is not installed. When either the AC or TP is installed, WTS_SERVICE_BASE_ADDRESS must be specified. Furthermore, the default language must be set for the component to be installed (see below).
WTS_SERVICE_BASE_A DDRESS		Address of the VTS service and port via which the clients communicate with the server. These parameters are mandatory when the TP or AC are installed, e.g. WTS_SERVICE_BASE_ADDRESS=WTSSERV:7001
LANGUAGE_AC LANGUAGE_TP LANGUAGE_CM		The language in which the administration software, Testplayer or control monitor is installed. The following languages are available: <ul style="list-style-type: none"> • cs-CZ: Czech • de-DE: German • en-US: English • es-ES: Spanish • fr-FR: French • it-IT: Italian • nl-NL: Dutch • pl-PL: Polish • pt-PT: Portuguese • ro-RO Romanian • ru-RU: Russian • sk-SK: Slovak • sl-SI : Slovene • sv-SE: Swedish • tr-TR: Turkish • zh-CN: Chinese Simplified

MANDANT_ID		This parameter can be used to set the multi-client with which the Testplayer should start (e.g. W12345_001). If "AUTO" is entered, the first multi-client found on the server will be selected. gefunden wird. If the multi-client should be entered for every start MANDANT_ID="-" should be entered.
ACTIVATE_CM	0/1	Setting for the Testplayer to use the control monitor (for "1"). With this setting, TP sends the necessary information on the control monitor.
RUN_CLIENT_SETUP	0	The execution of the client setup is suppressed.
ICON_AC ICON_TP ICON_HWT ICON_CM	0/1	Determines whether the corresponding Desktop icons are installed. During the Testplayer installation it can be specified whether an icon for the hardware test should be added in addition to the Testplayer icon.
CACHE_DIRECTORY	String	Specification of the path in which the cache of the administration software and the Testplayer should be established. Example: CACHE_DIRECTORY="d:\temp\schuhfried"
/exelang	1031 1033	Start setup in German (optional) Start setup in English (optional)

Examples:

Installation of the administration software with icon in English:

```
ClientSetup.exe /qr INSTALL_AC=1 ICON_AC=1 LANGUAGE_AC=en-US
WTS_SERVICE_BASE_ADDRESS=https://192.168.0.113:7001
```

Installation of the testplayer in German when using the control monitor and icons for the testplayer and the hardware test:

```
ClientSetup.exe /qr INSTALL_TP=1 ICON_TP=1 ICON_HWT=1
LANGUAGE_TP=de-DE MANDANT_ID=AUTO
WTS_SERVICE_BASE_ADDRESS=https://WTS_SERVER:7001
ACTIVATE_CM=1 CM_SERVICE_BASE_ADDRESS=https://WTS_CM_SERV:8888
```

Installation of the control monitor server in Italian:

```
ClientSetup.exe /qr INSTALL_CM=1 ICON_CM=1 LANGUAGE_CM=it-IT
```

Installation of the testplayer in German without control monitor using a certain multi-client with an icon for the testplayer:

```
ClientSetup.exe /qr INSTALL_TP=1 ICON_TP=1 LANGUAGE_TP=de-DE
MANDANT_ID=W12345_003
WTS_SERVICE_BASE_ADDRESS=https://WTS_SERVER:7001
CACHE_DIRECTORY="D:\Temp\Schuhfried"
```

Installation of the testplayer in English without control monitor using a certain multi-client with an icon for the testplayer:

```
ClientSetup.exe /qr INSTALL_TP=1 ICON_TP=1 LANGUAGE_TP=en-US
WTS_SERVICE_BASE_ADDRESS=https://WTS_SERVER:7001
MANDANT_ID=
```

Notes:

- The addresses of the server and of the control monitor can be entered using either the IP address or the domain name.
- If the multi-client should be **chosen every time when starting the testplayer**, the parameter "MANDANT_ID" may not be entered in the parameter string.
- Double quotation marks around the values of a property are not required, but permitted (e.g. DEFAULT_CULTURE="en-US"). However, it is not possible to assign a property (except MANDANT_ID) to a blank value. TP_PROP="" or LANGUAGE_TP= is not permitted and leads to an incorrect processing.
- It is important that the address of the VTS server and the port are correct and that the service is available during the installation. The installation is performed even if the server is not available but it is then not successful!
- The default value 0 can also be set explicitly for the parameter INSTALL_xx, ICON_xx and ACTIVATE_xx. This results in the respective component or the respective icon to NOT be installed (e.g. INSTALL_TP=0).
- A double slash (//) is a reserved string in the command line, therefore it is necessary to set the sign | before it. This applies in particular for URL information that starts with https://... Therefore, <https://my-domain:7001> must be written instead of https://my-domain:7001.
- The parameter /exelang must be at first place, if specified.

The clients can also be silently uninstalled. For this purpose, the following command, depending on the operating system, can be used:

```
msiexec /uninstall wts8clientsetup.msi /quiet
msiexec /uninstall wts8clientsetup.x64.msi /quiet
```

3.5 Updating the Vienna Test System

To update the Vienna Test System, simply follow the installation instructions that correspond to your system. Please **update the server first** and **then all the clients**.

After the update of the first client it has to be checked if the VTS system works properly.

Then the rest of the clients can be updated as well.

When starting a client, a check is performed whether the client version matches the server version. The client is not started should the versions not match.

Please be sure, that you have the **IP-address (or the name) of the server** when you update the clients, because you have to reenter them.

Please note that a possibly existing SW dongle will be maintained for an update. Furthermore, the specific properties of a virtual system may not change. Moving the virtual system invalidates the software dongle and locks your Vienna Test System. For further details, please contact SCHUHFRIED Support (see Section [5.3](#)) **before changing the server**.

The following properties of the virtual system **must remain the same** for the software dongle to remain valid:

- Virtual MAC address
- CPU properties
- UUID (Universal Unique Identifier) of the virtual image; the UUID is generated by the virtualization software. If a clone is created, a new UUID is generated.

3.6 License installation

3.6.1 Installing licenses

Software activation codes can only be installed via "license files". License files have the extension "V2C" or "SFLIC".

To import a license file into your system, proceed as follows:

1. Save the license file (extension "V2C" or "SFLIC") locally on the computer on which the Vienna Test System is installed.
2. Open the Vienna Test System and go to "Settings -> License Management -> Licenses".
3. Click on the "..." button (see below) and select the license file you have just saved. The file name will appear in the field to the left of the button.
4. Now click "**Apply Update**". A message appears confirming that the new licenses have been applied.

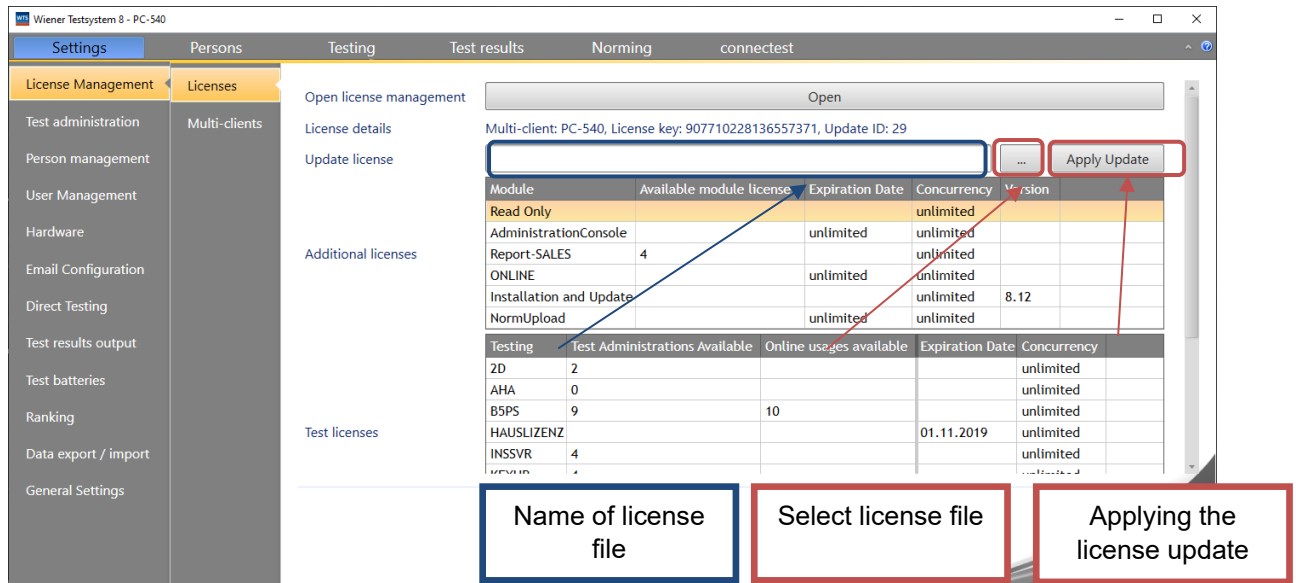

Figure 4: Installing additional licenses

Note:

- To install a license file, all license files so far must already be installed.
- The first license file of a system is already installed. Therefore, it must not be installed separately when installing the Vienna Test System.
- The license file with the extension "SFLIC" includes all previous license files. All missing license files will be installed automatically.

3.6.2 Installing the licenses without administration software

When a software dongle is used, the licenses must be installed before the Vienna Test System is installed. For this reason, the procedure from [3.6.1](#) cannot be used. **Only files with the extension "v2c"** may be installed via the Sentinel Admin Control Center. To enter the licenses you therefore need to proceed as follows:

1. Open your Internet browser and enter <http://localhost:1947> in the address bar.
2. The "Sentinel Admin Control Center" will open.
3. In the navigation bar on the left, select "Update/Attach".
4. Using "Browse ...", enter the license file you have received.
5. Click on "Apply File" to install the license.
6. You will receive confirmation that the licenses have been installed.

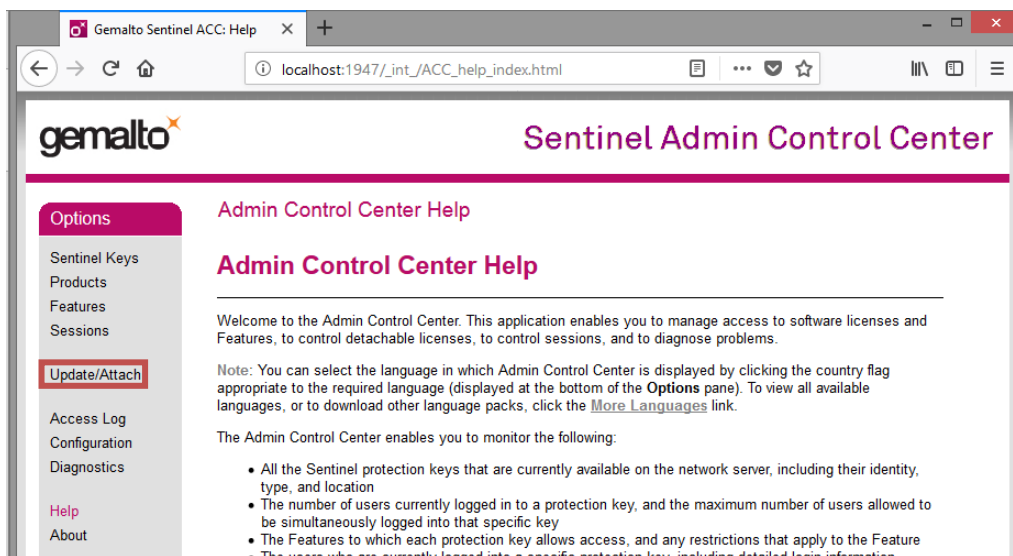

Figure 5: Sentinel Admin Control Center

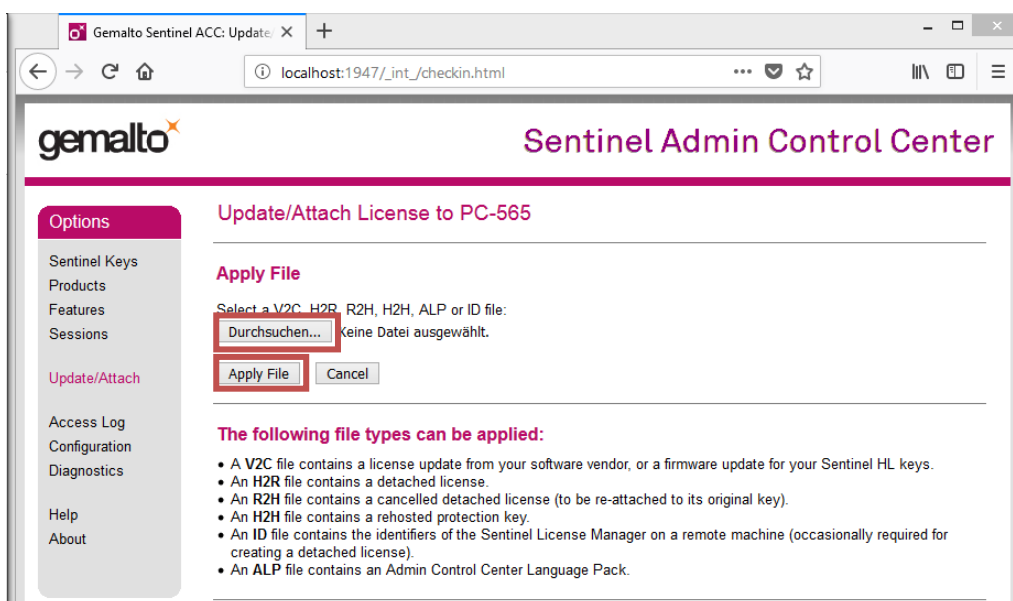

Figure 6: Entering licenses in the Sentinel Admin Control Center

3.7 Uninstalling the VTS:

The Vienna Test System can be removed from your computer as follows:

1. Open the Windows Control Panel via the Windows Start menu. This is done by going to **“Start“**→ **“Control Panel“**.
2. Double-click on **“Programs and Features“**.
3. Select **“Vienna Test System“**.
4. Click on **“Uninstall/change“**.
5. Select the **“Vienna Test System“** in the list of programs and click **“Change/Remove“**.
6. Follow the instructions and select **“Remove“**.

The databases, and hence all client details and results, **remains** on your system even if the VTS is uninstalled.

For further information please contact the help desk (see Section 5.3).

3.8 The control monitor

The **Control Monitor** is the Vienna Test System's program for monitoring and managing test stations in a client-server system. The program can be started on any computer after the installation of the client for the control monitor, with which the test stations can communicate. For each test station, it displays the following information:

- Name of the computer
- Person's details (name and date of birth)
- Test and test form currently being worked at this test station
- Various messages if a candidate requires assistance from the supervisor. If assistance is required, the "status" field flashes red/green and the warning appears under "status message" against the corresponding Testplayer.

The control monitor can also be used to end a break centrally if a break⁴ in the test battery is scheduled. If a person reaches the break, testing is halted until the supervisor ends the break centrally at the control monitor (using the button "End PAUSE at all work stations" – see Figure 7).

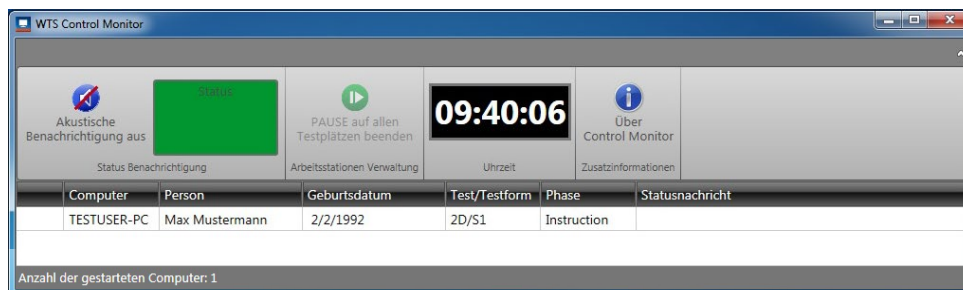

Figure 7: Control monitor

If a problem occurs at a test station (message indicating that the supervisor is needed), the control monitor signals this both optically and acoustically. The acoustic signal can be turned off via the button "Acoustic notification off".

3.8.1 Installing the control monitor

The control monitor can be installed on any computer on the network; it does not have to be the server on which the Vienna Test System services run.

Because the clients send information to the control monitor, it is important to ensure that the control monitor service and the Test Players can connect with each other.

To install the control monitor, check the "**Control Monitor**" component (see Section 3.4).

⁴ This functions only if the break "S1: Controlled by the test administrator" is being used.

3.9 Encrypted communication in VTS (HTTPS)

The communication between the clients and the server is implemented in VTS 8 with standardized Microsoft technology called Windows Communication Foundation (WCF). WCF offers multiple options for securing the communication. The version that is used by default in VTS ensures privacy, integrity, and end-to-end authentication between the clients and the server (message security). This variant is implemented at the application level and AES-256 is used for the encryption (<https://docs.microsoft.com/en-us/dotnet/framework/configure-apps/file-schema/wcf/message-of-wshttpbinding>).

Additional information on WCF Security is available here: <https://docs.microsoft.com/en-us/dotnet/framework/wcf/feature-details/security-overview>

The other APIs are hosted under HTTPS by default using a self-signed, trusted SSL certificate. See Section 3.10 on how to use your own certificate.

In general, VTS always uses encrypted communication. The necessary certificates are generated automatically.

3.9.1 Using your own HTTPS certificate

In order to use your own HTTPS certificate, the installation can be carried out via Command Line (example in Chapter 3.3.3). However, while it is possible to carry out the configuration later on, it is not recommended.

3.9.2 Using your own HTTPS certificate – Manual installation

In addition to the VTS service, the VTS contains further APIs that communicate via HTTPS. By default, the VTS Service and these APIs encrypt their communications with a trusted self-signed SSL certificate. However, it is also possible to use your own SSL certificate issued for the hosted domain.

The following steps are required:

- Make sure that your certificate is in My Certificates > Certificates (local computer)

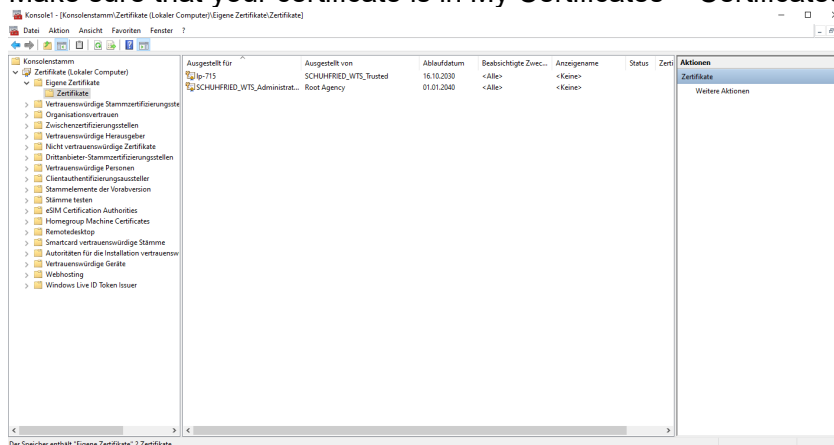

- Specify the name ("subject") of the certificate in the following config files:

- o "Installation path"\Vienna Test System 8\Service\WTSService.exe.config (under "findValue" of "serviceCertificate")

```
<behaviors>
  <serviceBehaviors>
    <behavior name="ServiceConfigHttp">
      <serviceMetadata httpGetEnabled="true"/>
      <!-- To receive exception details in faults for debugging purposes, set the value below to true. Set to false before deployment to avoid disclosing e
    <serviceDebug includeExceptionDetailsInFaults="false"/>
      <dataContractSerializer maxItemsInObjectGraph="6553600"/>
    </serviceBehavior>
    <serviceBehaviors>
      <behavior name="ServiceCertificate">
        <serviceCertificate findValue="SchuhfriedSelfSignedCertificate" storeLocation="LocalMachine" storeName="My" x509FindType="FindBySubjectName" />
      </serviceBehavior>
    </serviceBehaviors>
  </behaviors>
  <serviceHostingEnvironment multipleSiteBindingsEnabled="true"/>
  <extensions>
    <behaviorExtension type="WTS.Business.Common.CommonCore.Configuration.TimeSyncFreeEndpointBehavior, WTS.Business.Common.CommonCore,
  </behaviorExtensions>
</extensions>
```

- o "Installation path"\Vienna Test System 8\Api\appsettings.json" and
- o "Installation path"\Vienna Test System 8\Identity\appsettings.json"

```
"Kestrel": {
  "Endpoints": {
    "Http": {
      "Url": "http://testsetupenv-rm:7012"
    },
    "HttpsInlineCertStore": {
      "Url": "https://testsetupenv-rm:7013",
      "Certificate": {
        "Subject": "testsetupenv-rm",
        "Store": "My",
        "Location": "LocalMachine",
        "AllowInvalid": "true" // Set to true to allow invalid certificates (e.g. self-signed)
      }
    }
  }
}
```

- Bind the certificate to https.sys
 - o Find the fingerprint of the previously imported certificate:
 - I. Navigate to the certificate to be imported and double-click it
 - II. Go to the "Details" tab and look for "Fingerprint" in the "Field" column

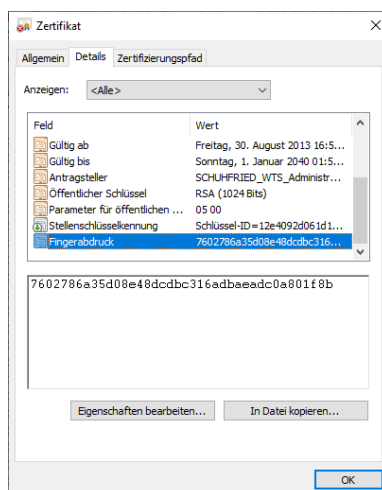

- III. Copy the value of the fingerprint (remove spaces, should there be any) 7602786a35d08e48dcd316adbaeacd0a801f8b
- IV. Open the Windows Command Prompt (cmd.exe) with administrator rights

- V. Prepare the command for binding (change **SERVICEPORT** and **THUMBPRINT**)
`netsh http add sslcert ipport=0.0.0.0:SERVICEPORT
 certhash=THUMBPRINT appid={76ac1965-2c8f-4f47-9251-9d8f357a7a3d}`
- VI. The command should look as follows, run it in the Windows Command Prompt
`netsh http add sslcert ipport=0.0.0.0:7001
 certhash=7ffd45b2302b3c17fc47e74cfed80288fb25569c
 appid={76ac1965-2c8f-4f47-9251-9d8f357a7a3d}`
- VII. If binding was successful you should see something like “SSL Certificate successfully installed”
- VIII. To verify certificate being installed run this command “netsh http show sslcert”
- IX. Then you should see something like this:

```

Administrator: Command Prompt
C:\Users\Administrator>netsh http show sslcert
SSL Certificate bindings:
-----
IP:port                : 0.0.0.0:7001
Certificate Hash       : 7FFD45B2302B3C17FC47E74CFED80288FB25569C
Application ID         : {76AC1965-2C8F-4F47-9251-9D8F357A7A3D}
Certificate Store Name : My
Verify Client Certificate Revocation : Enabled
Verify Revocation Using Cached Client Certificate Only : Disabled
Usage Check            : Enabled
Revocation Freshness Time : 0
URL Retrieval Timeout : 0
Ctl Identifier         : (null)
Ctl Store Name        : (null)
DS Mapper Usage       : Disabled
Negotiate Client Certificate : Disabled

C:\Users\Administrator>_
  
```

- o Restart the VTS service

3.9.3 Configuring the VIS Universal Plugin via encrypted connection over HTTPS

The following steps describe how to configure the universal plugin via HTTPS by using the self-signed certificate provided with the setup or your own SSL certificate.

The following steps are required:

- (optional, when you use your own certificate) Make sure your certificate is available under My Certificates > Certificates (local computer)

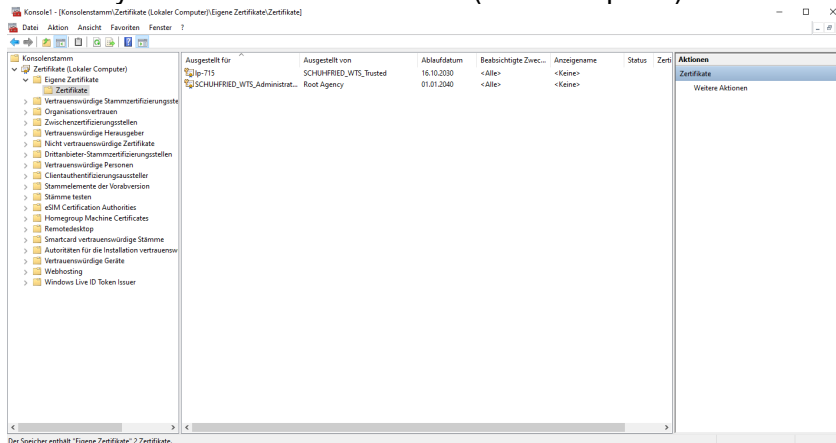

- (optional, when you use your own certificate) Specify the name ("subject") of the certificate in "Installation path" \Vienna Test System 8\Service\Plugin\WTS.Integration.Plugins.Universal.UniversalPlugin.dll.config (under "findValue" of "serviceCertificate")

```
<behavior>
  <serviceBehaviors>
    <behavior name="serviceConfigHttps">
      <serviceMetadata httpGetEnabled="true"/>
      <!-- To receive exception details in faults for debugging purposes, set the value below to true. Set to false before deployment to avoid disclosing -->
      <serviceDebug includeExceptionDetailInFaults="false"/>
      <dataContractSerializer maxItemsInchSet="4096"/>
      <serviceCredentials>
        <useNameAuthentication useNamePasswordValidationMode="Custom" customUserPasswordValidatorType="WTS.Business.Common.CommonCore.Configuration.Cu
        <!--SchuhfriedSelfSignedCertificate - trusted root certificate that needs to be installed on the machine out of Schuhfried Root Authority-->
        <serviceCertificate findValue="SchuhfriedSelfSignedCertificate" storeLocation="LocalMachine" storeName="My" #109FindType="FindBySubjectName" />
        <clientCertificate>
          <authentication certificateValidationMode="None"/>
        </clientCertificate>
      </serviceCredentials>
    </behavior>
  </serviceBehaviors>
</behavior>
<endpointBehaviors>
  <behavior name="TimeSyncFreeEndpointBehavior">
    <timeSyncFreeEndpointBehavior />
  </behavior>
</endpointBehaviors>
</behavior>
<serviceHostingEnvironment multipleSiteBindingsEnabled="true"/>
<extensions>
  <behaviorExtensions>
    <add name="timeSyncFreeEndpointBehavior" type="WTS.Business.Common.CommonCore.Configuration.TimeSyncFreeEndpointBehavior, WTS.Business.Common.CommonCore,
  </behaviorExtensions>
</extensions>
```

- Bind the certificate to https.sys
 - Find the fingerprint of the previously imported certificate:
 - I. Open "Manage Certificates" and navigate to Personal > Certificates
 - II. Find the "Fingerprint" of either SchuhfriedSelfSignedCertificate or your own certificate

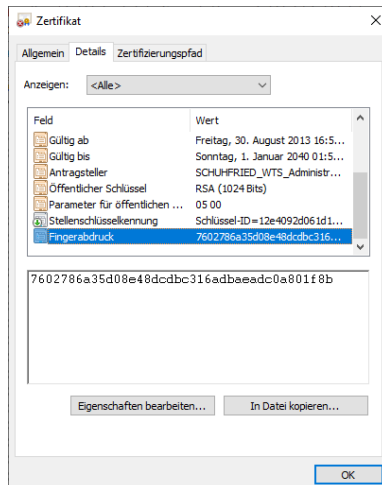

- III. Copy the value of the fingerprint (remove spaces, should there be any)
7ffd45b2302b3c17fc47e74cfed80288fb25569c
- IV. Open the Windows Command Prompt (cmd.exe) with administrator rights
- V. Prepare the command for binding (change **SERVICEPORT** and **THUMBPRINT**)
netsh http add sslcert ipport=0.0.0.0:**SERVICEPORT**
certhash=**THUMBPRINT** appid={f1a6cd02-6d60-4bea-822b-5f55cfac45a9}
- VI. The command should look as follows, run it in the Windows Command Prompt
netsh http add sslcert ipport=0.0.0.0:9010
certhash=7ffd45b2302b3c17fc47e74cfed80288fb25569c
appid={f1a6cd02-6d60-4bea-822b-5f55cfac45a9}
Note: When you update VIS from a version that is already using HTTPS, you need to remove the SSL Certificate mapping by executing the following command:
netsh http delete sslcert ipport=0.0.0.0:9010
- VII. If binding was successful you should see something like
"SSL Certificate successfully installed"
- VIII. Run this command to verify the certificate that is being installed
- IX. "netsh http show sslcert"
- X. You should then see something like this:

```

Command Prompt
Extended Properties:
PropertyId : 3
IP:port : 0.0.0.0:9010
Certificate Hash : 355ea0ea98d729778127b0ac68d249bdece00
Application ID : {f1a6cd02-6d60-4bea-822b-5f55cfac45a9}
Certificate Store Name : (null)
Verify Client Certificate Revocation : Enabled
Verify Revocation Using Cached Client Certificate Only : Disabled
Usage Check : Enabled
Revocation Freshness Time : 0
URL Retrieval Timeout : 0
CEL Identifier : (null)
CEL Store Name : (null)
DS Mapper Usage : Disabled
Negotiate Client Certificate : Disabled
Reject Connections : Disabled
Disable HTTP2 : Not Set
Disable QUIC : Not Set
Disable TLS1.2 : Not Set
Disable TLS1.3 : Not Set
Disable OCSP Stapling : Not Set
Enable Token Binding : Not Set
Log Extended Events : Not Set
Disable Legacy IIS Versions : Not Set
Enable Session Tickets : Not Set
Extended Properties:
PropertyId : 0
Receive Window : 1048576
  
```

- Restart the WTS Integration Service

3.9.4 Configuring the VIS Universal Plugin via an encrypted connection over HTTP

Per default, VIS is installed by the setup for HTTPS and the previous chapter contains instructions on how to properly bind the port used by VIS with the corresponding HTTPS certificate. If HTTP needs to be used for some reason (e.g. due to migrating from an earlier version of VTS), the following steps need to be performed to assure that VIS is still communicating properly over HTTP after updating:

- Stop the VTS Integration Service (only if it was running)
- In "Installation path"\Vienna Test System 8\ServicePlugin\WTS.Integration.Plugins.Universal.UniversalPlugin.dll.config comment out "service" node with the comment "HTTPS configuration, primary use" and uncomment "service" node with the comment "HTTP configuration, legacy use"

```
<services>
  <!--HTTPS configuration, primary use-->
  <!--<service behaviorConfiguration="HttpsBehaviour"
    name="WTS.Integration.Plugins.Universal.UniversalPlugin.Service.UniversalPluginService">-->
  <!--MEX Endpoint for enabling client creation-->
  <!--<endpoint address="mex" binding="mexHttpsBinding" bindingConfiguration=""
    name="MetadataEndpoint" contract="IMetadataExchange" />-->

  <!--<endpoint address="Universal" binding="basicHttpsBinding"
    bindingConfiguration="basicHttpsBindingConfig" name="Standard"
    contract="WTS.Integration.Plugins.Universal.UniversalPlugin.Service.IUniversalPluginService" />
  <endpoint address="UniversalSpecialCase" binding="basicHttpsBinding"
    bindingConfiguration="basicHttpsBindingConfig" name="Special"
    contract="WTS.Integration.Plugins.Universal.UniversalPlugin.Service.IUniversalPluginSpecialCaseService" />

  <endpoint address="UniversalServiceStreamed" binding="basicHttpsBinding"
    bindingConfiguration="basicHttpsBindingConfigStreamed"
    name="Streamed"
    contract="WTS.Integration.Plugins.Universal.UniversalPlugin.Service.IUniversalPluginServiceStreamed" />

  <host>
    <baseAddresses>-->
    <!--<add baseAddress="https://{some_domain}:9010" />-->
    <!--</baseAddresses>
  </host>
</service-->

  <!--HTTP configuration, legacy use-->
  <service behaviorConfiguration="HttpBehaviour"
    name="WTS.Integration.Plugins.Universal.UniversalPlugin.Service.UniversalPluginService">

  <!--MEX Endpoint for enabling client creation-->
  <endpoint address="mex" binding="mexHttpBinding" bindingConfiguration=""
    name="MetadataEndpoint" contract="IMetadataExchange" />

  <endpoint address="UniversalService" binding="wsHttpBinding"
    bindingConfiguration="WSHttpBinding" name="Standard"
    contract="WTS.Integration.Plugins.Universal.UniversalPlugin.Service.IUniversalPluginService" />
  <endpoint address="UniversalServiceSpecialCase" binding="wsHttpBinding"
    bindingConfiguration="WSHttpBinding" name="Special"
    contract="WTS.Integration.Plugins.Universal.UniversalPlugin.Service.IUniversalPluginSpecialCaseService" />

  <endpoint address="UniversalServiceStreamed" binding="basicHttpBinding"
    bindingConfiguration="basicHttpBindingConfigStreamed"
    name="Streamed"
    contract="WTS.Integration.Plugins.Universal.UniversalPlugin.Service.IUniversalPluginServiceStreamed" />

  <host>
    <baseAddresses>
    <add baseAddress="http://localhost:9010" />
    </baseAddresses>
  </host>
</service>
```

- Start VTS Integration Service

3.10 Manual adjustments to the system after the installation

3.10.1 Changing the name of the machine after the installation

If no full-value SSL certificate is used, changing the machine name should absolutely be avoided for an already installed Vienna Test System since the self-signed SSL certificate provided is tied to the machine name and thus the communication of the respective components no longer is configured correctly once the name is changed.

If this does occur, take the following steps:

1. Uninstall the Vienna Test System (this does not delete the database)
2. Ensure that the certificate "SchuhfriedSelfSignedCertificate" is deleted:
 - a. Open "Certificate Management" (Run "certlm.msc" on the local computer)
 - b. Go to "Personal" -> "Certificates"
 - c. Right-click "SchuhFriedSelfSignedCertificate" and select Delete
3. Reinstall the Vienna Test System (the existing database is recognized and used).
4. Adjustments in the VTS database by means of SQL script to take over the new computer names. (update_identityserverconfiguration.sql).

It is important to use the same version for uninstalling and reinstalling the Vienna Test System.

3.10.2 Reconfiguring the Bitly settings

For sending test invitation links, the VTS System uses the external tool "Bitly" to shorten the test links. The following settings can be overwritten in the VTS configuration file:

1. **IsBitlyEnabled**

This setting provides a possibility to enable/disable the usage of the Bitly tool. Valid values are "true" and "false".

Here is an example configuration entry:

```
<add key="IsBitlyEnabled" value="false"></add>
```

2. **BitlyAccessToken**

This setting provides a possibility to use another Bitly account for the link shortening. The access token can be generated online for every User account.

Here is an example configuration entry:

```
<add key=" BitlyAccessToken" value=" 123456789abcdefghijklmnopq"></add>
```

3.11 Notes on backing up the database and restoring the VTS System

Should the VTS System be restored on another computer, the database must be configured using an SQL script (update_identityserverconfiguration.sql).

3.12 Setting up TestPlayer Web with a reverse proxy via IIS

TestPlayer Web is hosted in Kestrel. However, additional configuration options that Kestrel does not offer are required sometimes (e.g. port sharing). In this case, a reverse proxy can be configured via Internet Information Services (IIS).

The following steps are required to do so:

1. Install the IIS Modules Application Request Routing (ARR) and URL Rewrite
 Note: you can install these modules using the Web Platform Installer (<https://docs.microsoft.com/en-us/iis/install/web-platform-installer/web-platform-installer-direct-downloads>). If some of the modules cannot be installed successfully via Web Platform Installer, download and install them directly from <https://www.microsoft.com/en-us/download> instead.

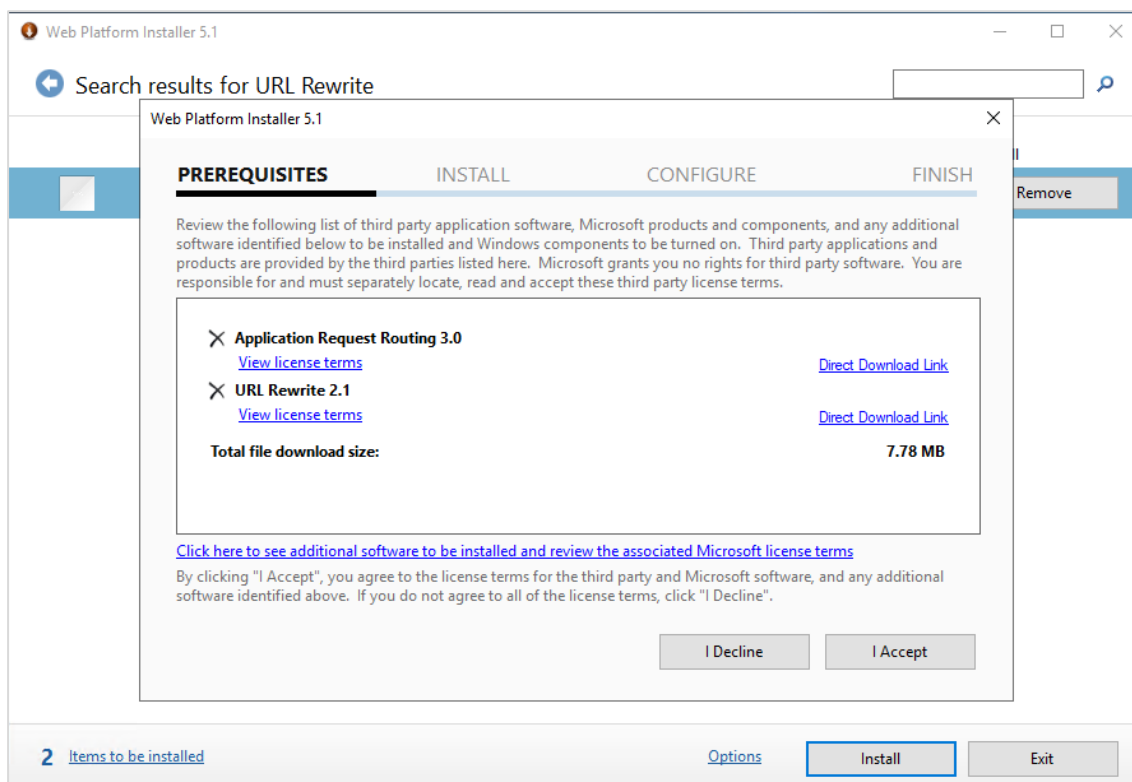

2. Start IIS and go to Application Request Routing and check Enable Proxy and click on Apply

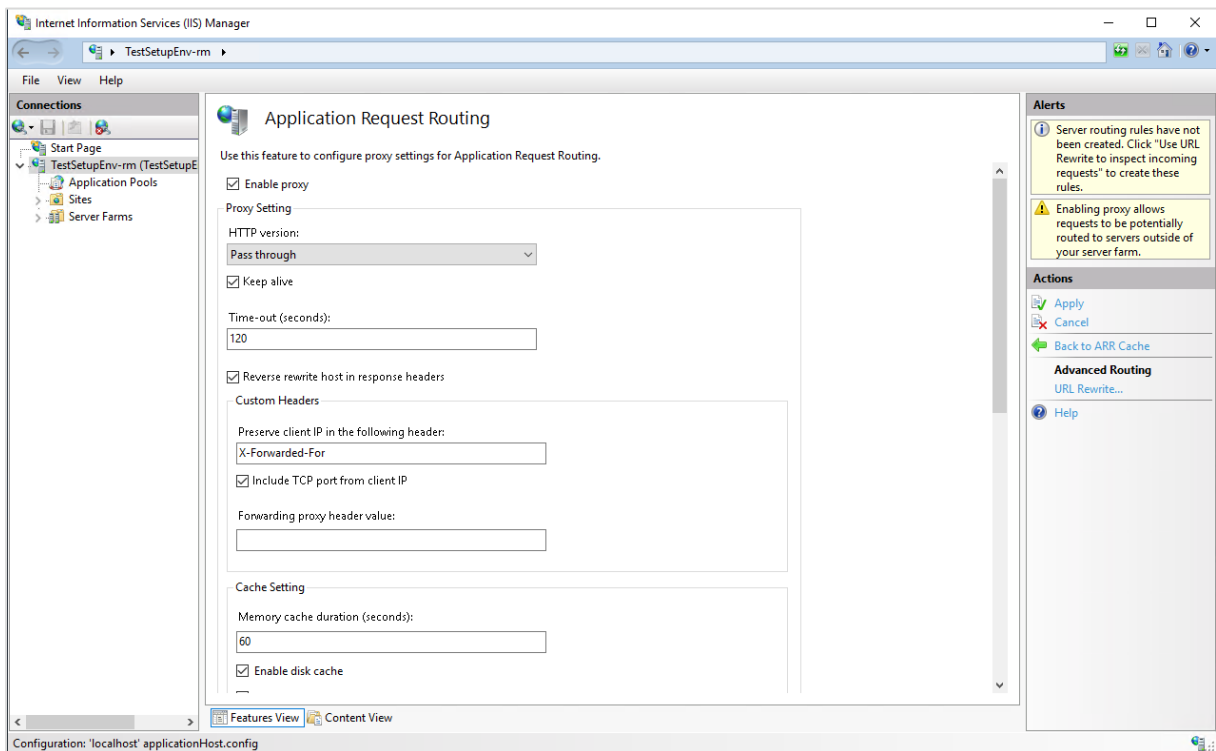

3. Go to a website (either a default website or create a new one) and click on URL Rewrite
4. Configure a new reverse proxy rule
 - a. Click on Add Rule(s)...
 - b. Select Reverse Proxy

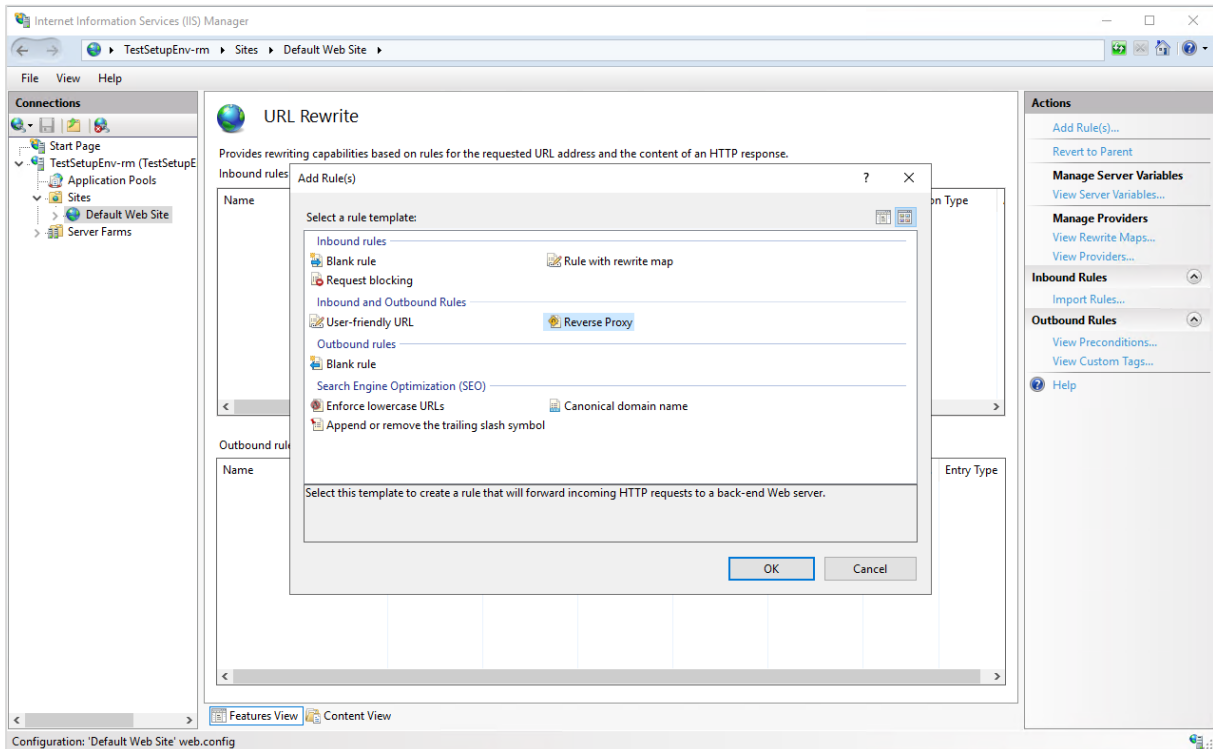

- c. Under Inbound rules, enter “{domain}:7017”, where domain represents the domain under which TestPlayer Web is hosted in Kestrel
- d. Uncheck Enable SSL Offloading
- e. Check “Rewrite the domain names of the links in HTTP responses” and set the domain under “To:”. Click on OK.

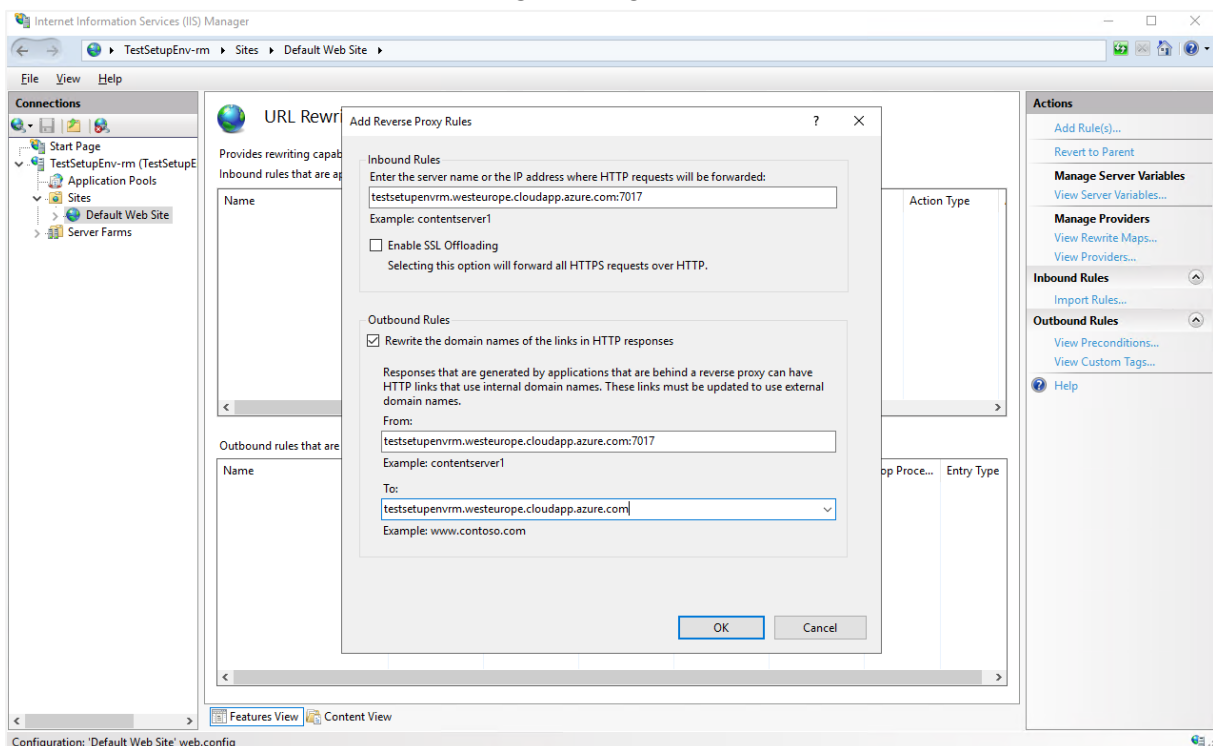

- Right click on the website and select “Edit bindings” and, if it does not already exist, create a binding for HTTPS. For “SSL certificate” you can select the certificate installed by the setup or you can use your own certificate issued for the configured domain. Click on OK.

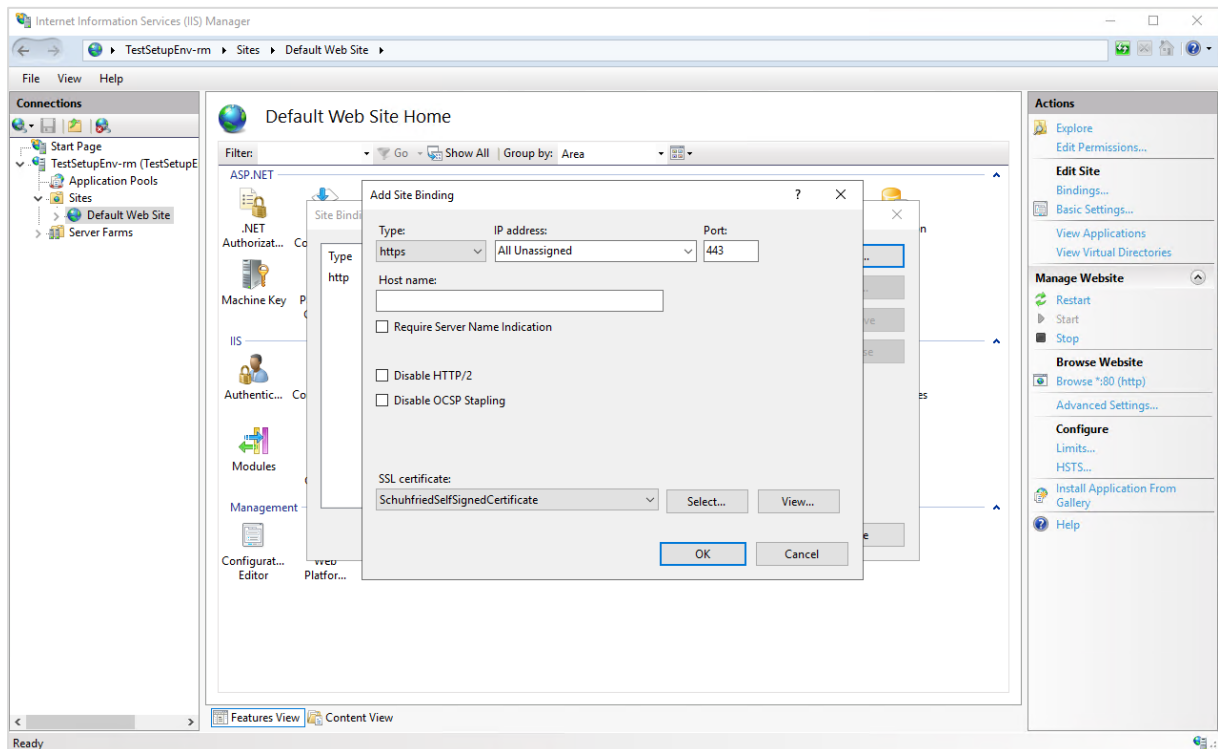

If everything has been configured properly, you should see following content when you navigate to the configured domain:

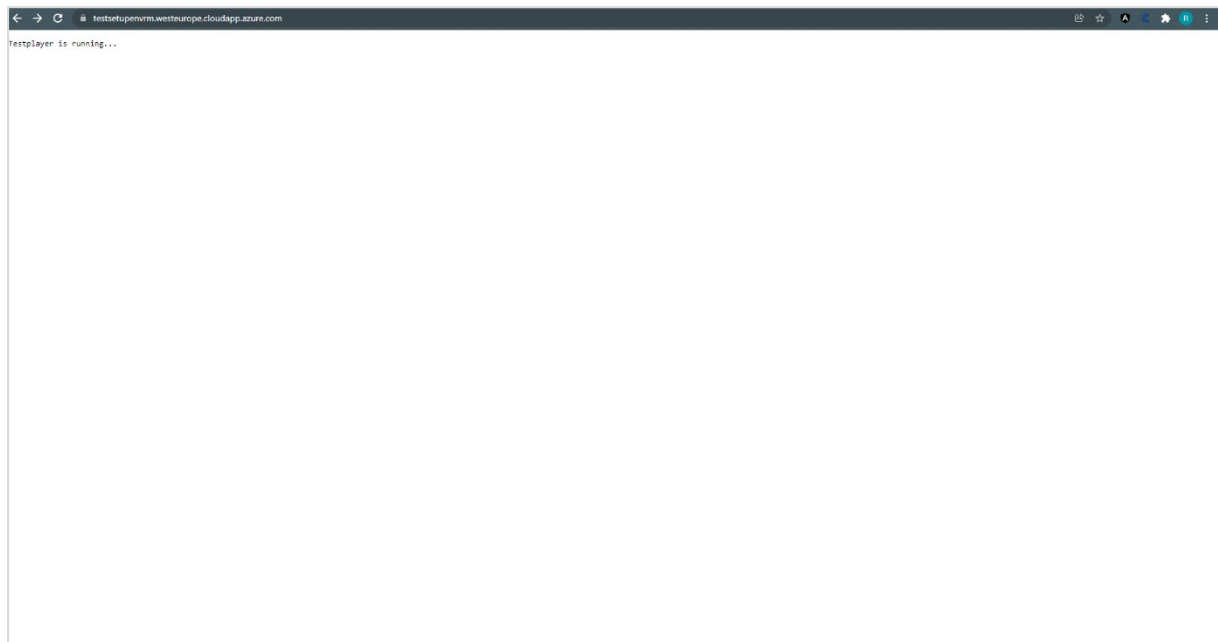

Note: In order for the reverse proxy to be configured properly, the added website cannot contain a virtual directory!

4 DESCRIPTION OF PERIPHERAL DEVICES

4.1 Test system dongle

4.1.1 Scope of delivery

- 1 test system dongle
- 1 set of red, green, yellow and black stickers (not included if a Response Panel is supplied)



IMPORTANT!

Your test system dongle contains the licenses for all your Vienna Test System software.

If you do not have a Response Panel but wish to administer tests for which the coloured buttons are required, the following keys on the computer keyboard can be used instead:

Red button: left Ctrl (Strg)- or Alt (Alt)- or Shift (⇧)- key

Green button: Right (Strg)- or Alt (Alt)- or (⇧)- key

Yellow button: Backspace key ←

Black key: Space bar (Space)

Alternatives are provided since on many keyboards (particularly laptop keyboards) some keys are not in a convenient position for use. Choose the most conveniently located keys for each purpose and mark them with the coloured stickers supplied.

4.1.2 Specification

Power supply	5V via the USB cable
Power consumption	max. 30mA
Max. dimensions (w x h x d)	15 x 8 x 75mm
Weight (without accessories)	9.5g
Storage temperature	-20 - 60°C
Operating temperature	10 - 30°C
Relative atmospheric humidity	max. 70%, non-condensing

4.2 Response panels

4.2.1 Scope of delivery

- 1 Response Panel, Advanced (Ag) or Universal (Ug)
- 2 joystick levers (only for Response Panel Ug)
- 2 joystick templates (only for Response Panel Ug)

Response Panel, Advanced



- 7 colour keys, 10 number keys, 1 sensor key
- 2 twist buttons
- Connection for foot-operated keys
- Connection for foot pedals - analogue
- Sound generator (speaker)
- Connectors for headphones and microphone (jack plug)

Response Panel, Universal



- 7 colour keys, 10 number keys, 1 sensor key
- 2 twist buttons
- 2 analogue joysticks
- 2 joystick guides
- Connection for foot-operated keys
- Connection for foot pedals - analogue
- Sound generator (speaker)
- Connectors for headphones and microphone (jack plug)

4.2.2 Commissioning

Connect the response panel to the computer via the USB cable, on which the Vienna Test System is installed. Connect the USB cable to the USB-B connector on the rear of the response panel and the other end into a free slot (USB-A connector) to your computer.

Figure 8 shows the connection options of the response panel.

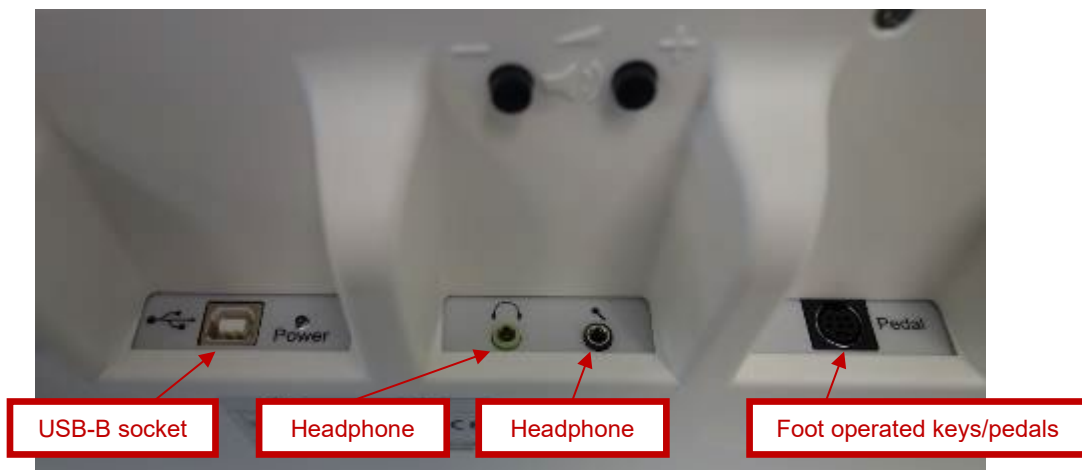

Figure 8: Connection options of the response panel

4.2.3 Joystick guides

The joystick template is inserted as shown (see Figure 9) to the response panel Ug. For easy mounting the Joystick can be deducted.



Figure 9: Joystick guide mounted on the response panel

Joystick guides are used in some tests to restrict movement of the joystick to one direction only. The following symbols are used in the instructions for these tests (see Figure 10).



Figure 10. Symbols of the joystick guide

4.2.4 Sound Out- and Input

The sound output in the Vienna Test System are made through the internal speaker or a headset (sold separately). The headset can be connected via one 3.5mm jack for headphones and microphone on the response panel. The sockets for the connection of the headset are marked with a headphone and a microphone icon.

Use a free USB port on the computer if a USB headset is used. The internal speaker of the response panel is turned off if a headset is plugged in.

The volume can be adjusted with the buttons (+) and (-) at the back of the response panel. It cannot set to zero.

4.2.5 Foot pedals and analog foot pedals

The connection of both types of foot pedals (available as an accessory) is done via a single connector. The connector is labeled with the phrase "pedal". Connect as needed either the foot pedals or the analog foot pedals.

4.2.6 Specification

Power supply	+5V via the USB cable
Power consumption	max. 500mA
Protection class	
Device type	B
max. USB cable length	3m
max. cable length of the headset	3m
max. dimensions (w x h x d)	495 x 50 x 230mm
Weight (without accessories)	1.495kg
Storage temperature	-20 - 60°C
Operating temperature	10 - 30°C
Relative atmospheric humidity	max. 70%, non-condensing

4.3 Foot Pedals

The foot-operated keys are connected to the rear of the Response Panel (see Figure 8).

4.3.1 Scope of delivery

- 1 pair of foot-operated keys (left & right)



4.3.2 Specification

Max. dimensions (w x h x d)	each 160 x 55 x 310mm
Weight (without accessories)	1,55 kg
Storage temperature	-20 to 60°C
Operating temperature	10 to 30°C
Relative atmospheric humidity	max. 70%, non-condensing

4.4 Analog Foot Pedals

The analog foot pedals are connected to the Response Panel Universal (see Figure 8).

4.4.1 Scope of delivery

- 1 pair of analogue foot pedals (left & right)



4.4.2 Specification

Max. dimensions (w x h x d)	each 80 x 60 x 200mm
Weight (without accessories)	0.85kg
Storage temperature	-20 - 60°C
Operating temperature	10 - 30°C
Relative atmospheric humidity	max. 70%, non-condensing

4.5 MLS Work Panel

4.5.1 Scope of delivery

- 1 MLS Work Panel
- 2 styluses (red = left, black = right)
- 2 stylus holders
- 2 pin holders each with 25 short pins
- 2 pin holders each with 25 long pins

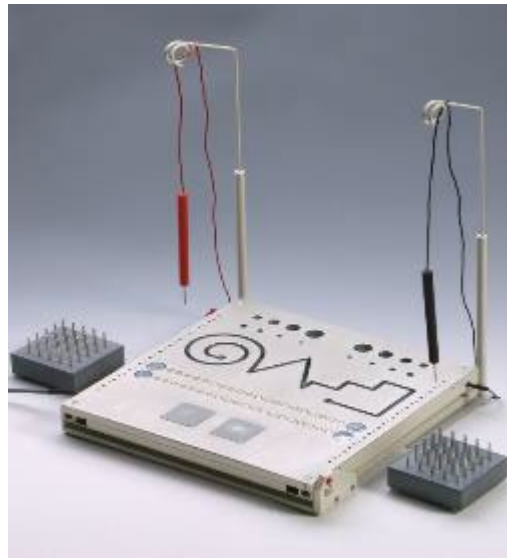

The MLS Work Panel features:

- Holes of varying diameters
- A winding groove with several bends and angles
- 2 x 20 contact points
- 25 small holes on either side
- 2 small plates for tapping

4.5.2 Specification

Power supply	5V via the USB cable
Power consumption	max. 500mA
Protection class	□
Device type	B
Max. dimensions (w x h x d)	310 x 50 x 300mm
Weight (without accessories)	5.4kg
Storage temperature	-20 - 60°C
Operating temperature	10 - 30°C
Relative atmospheric humidity	max. 70%, non-condensing

4.6 Flicker fusion unit

4.6.1 Scope of delivery

- 1 Flicker Fusion Unit

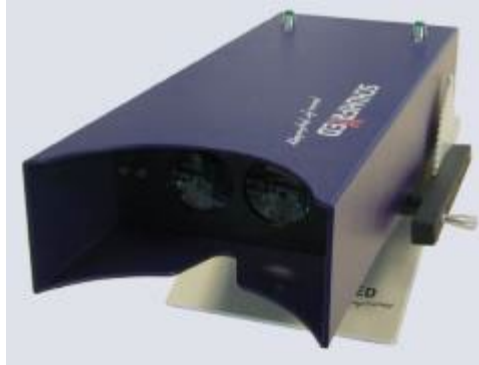

Light stimulus source:

Red, diffuse light-emitting diode with a wavelength of 655nm and a light intensity of 5.4 mcd. The light pulse output consists of rectangular impulses that can be set in increments of 0.1 Hertz in the range 10.0 - 100.0 Hertz with a duty cycle of 50%.

Ambient lighting:

The ambient environment has a diameter of 30mm and an intensity of 600 mcd.

The optical system:

2 lenses (concave-convex) with a focal length of 250mm generate a virtual image of the stimulus at a distance of 12m.

Visual angle for stimulus: 1.2°

Visual angle for ambient background: 10°

4.6.2 Specification

Power supply	5V via the USB cable
Power consumption	max. 500mA
Protection class	□
Device type	B
Max. dimensions (w x h x d)	160 x 100 x 400mm
Weight (without accessories)	1.8kg
Storage temperature	-20 - 60°C
Operating temperature	10 - 30°C
Relative atmospheric humidity	max. 70%, non-condensing

4.7 Peripheral Perception 2 (PP-HW2)

4.7.1 Scope of delivery

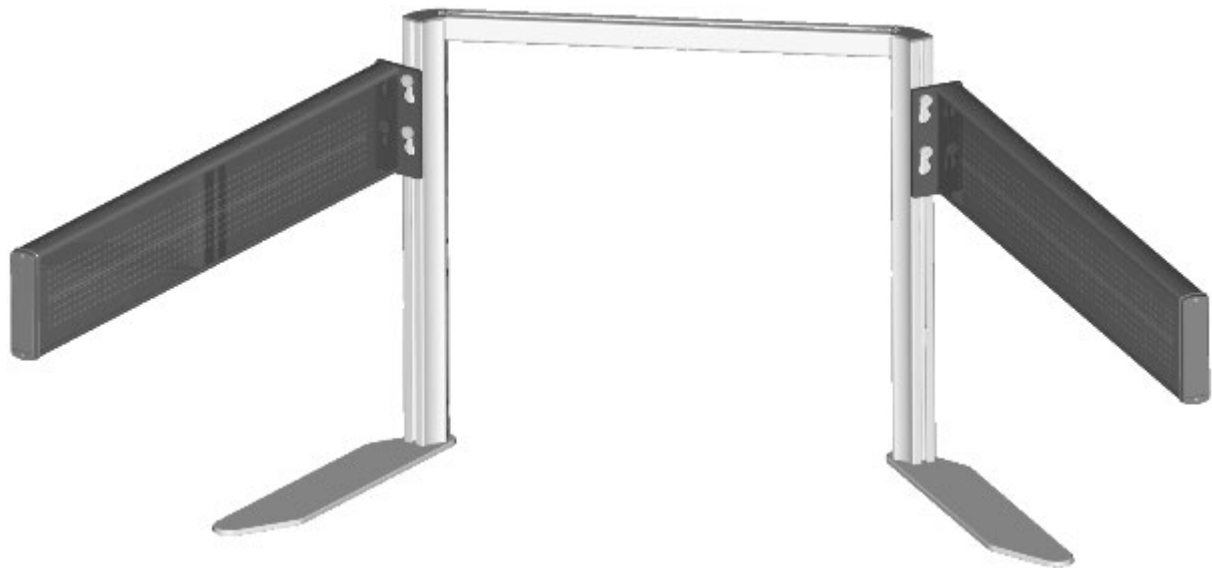

Pos.	Qty..	Description
1	1	Left display element
2	1	Right display element
3	1	Crossbar
4	1	Connecting cable 20pol./1m
5	1	Connecting cable USB/3m
6	1	Right pedestal
7	1	Left pedestal
8	1	Power adapter 5V/4A

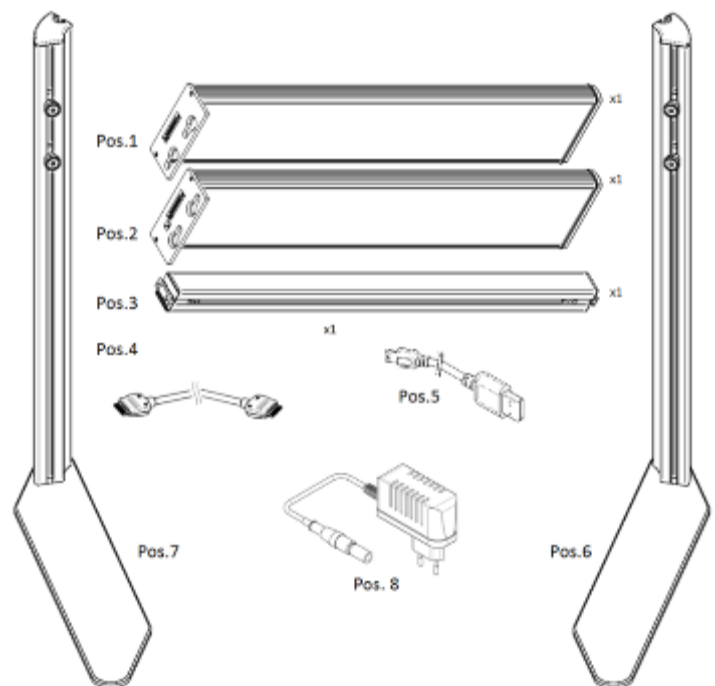

4.7.2 Mechanical assembly

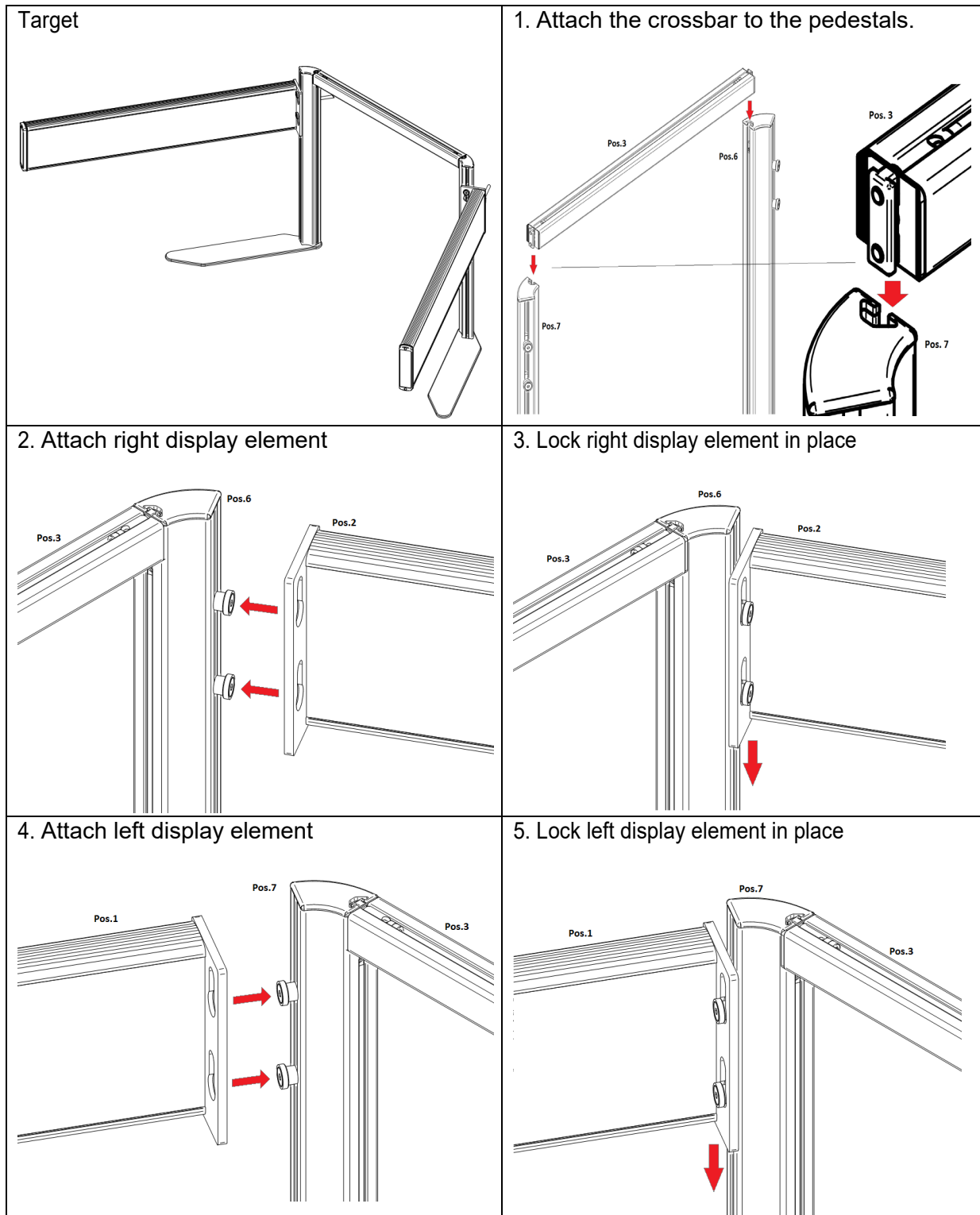

4.7.3 Cabling

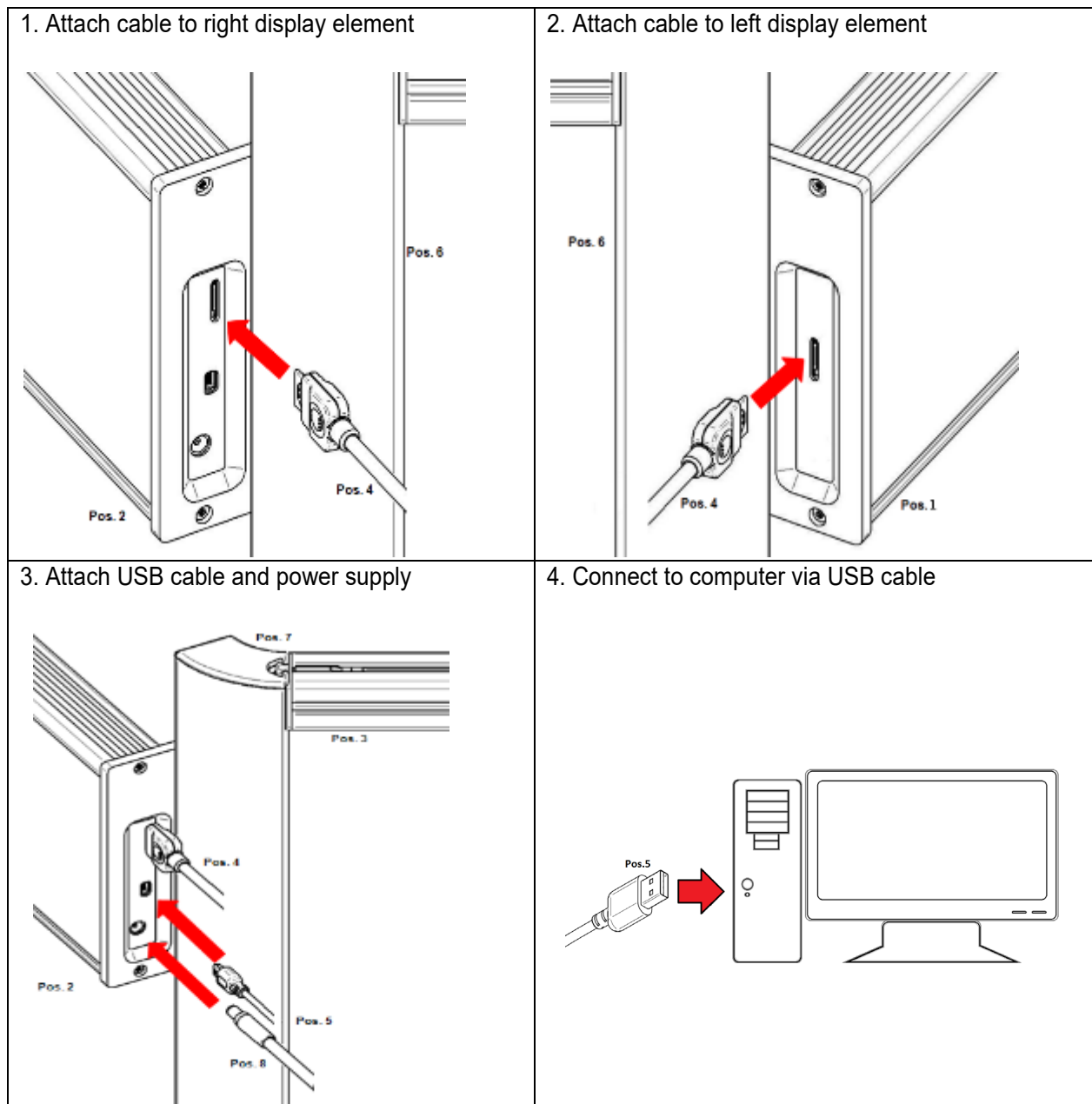

IMPORTANT:

- The device must only be used with the parts supplied with it.
- Do not use any power adapter except the one made by CINCON ELECTRONICS CO., LTD. model no. TR30RAM050, that is provided with the unit.

Before using the device, the cables must be connected. First connect the two display elements (items 1 and 2) with the connecting cable provided (item 4). The jack on either end of the connecting cable can be plugged into either the left or right display element. See steps 1 and 2.

Then connect the USB cable (item 5) to the right display element (item 2) and the computer (steps 3 and 4).

Power is supplied via the power adapter provided (item 8), which is also connected to the right display element (item 2) (step 3). The power adapter (item 8) must also be plugged into a mains socket.

To disassemble the device, follow the cabling instructions in reverse order.

Place the respondent's monitor in the space between the Peripheral Perception display elements so that the front of the monitor is level with the frame to which the display elements are attached.

4.7.4 Specification

Operating voltage	5V / 4A
Output	20W
	Protection class I; device type B
Max. dimensions (w x h x d)	1450 x 560 x 800 mm
Weight (without accessories)	9,6kg
Storage temperature	-20 to 60°C
Operating temperature	10 to 30°C
Relative atmospheric humidity	max. 70%, non-condensing
Power adapter	Manufacturer: CINCON Electronics Co., LTD. Model: TR30RAM050 Output: 5V DC 4.0A

4.7.5 Environmental requirements

The test environment should allow the respondent to work the test undisturbed. Disruption from visual and acoustic stimuli must be avoided.

The ambient brightness must not be greater than 2500 lux; at levels higher than this there will be insufficient contrast with the stimuli presented in the test. If the ambient brightness is greater than 2500 lux, it should be reduced.

The ambient brightness is measured by a special brightness sensor in the PP-R hardware. If it is too high, the system prevents the test being administered.

4.7.6 The respondent's position

The respondent should adopt the sitting position described in Section 2. It is important that the respondent's head is positioned between the two display elements. The head should be level with the white markings in the center of the sensor bars. This allows the device to determine the position of the head.

The distance between the metal frame and the face **should be between 20 and 45 cm**. This distance is measured by the PP-R hardware. If the distance is incorrect, the Vienna Test System provides feedback.

The lateral distance between the head and the center of the screen should be no more than 10 cm. This distance is also measured by the PP-R hardware. If the distance is too great, the Vienna Test System provides feedback.

The correct (and examples of wrong) seating position is shown schematically in Figure 11. To adjust the vertical position of the display elements better, there are two positions where they can be hooked. For larger people the upper hanging rack is to be used, with smaller positions (or children) is the Lower preferable.

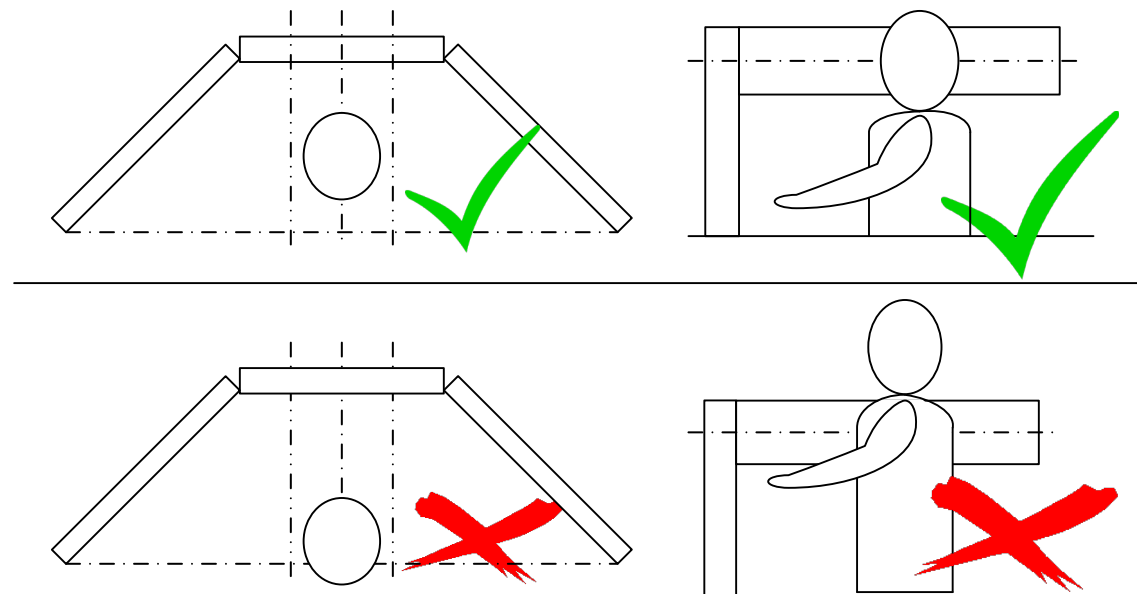

Figure 11: Correct (above) and wrong (below) seating position with the PP-R

4.7.7 Safety note

IMPORTANT: To prevent the RISK of electric shock, the device must only be connected to an ELECTRICITY SUPPLY that has a protective earth.

5 Help

5.1 Vienna Test System help functions

The Vienna Test System includes a comprehensive and context-sensitive Help section. Here you will find all the information you need, on subjects ranging from installation and use of the VTS to “Tips and Tricks” and literature references.

You can consult the Help section at any time by clicking the  button.

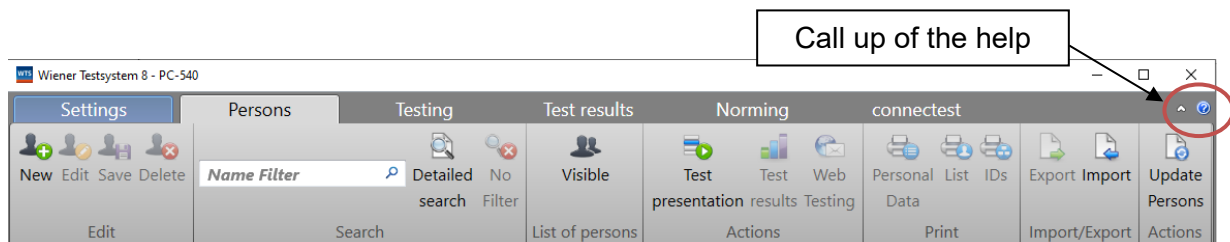

Figure 12: Call up of the help of the Vienna Test System

Figure 13 shows the Vienna Test System’s help window. Here you can search for keywords (magnifying glass symbol) and navigate to any required section.

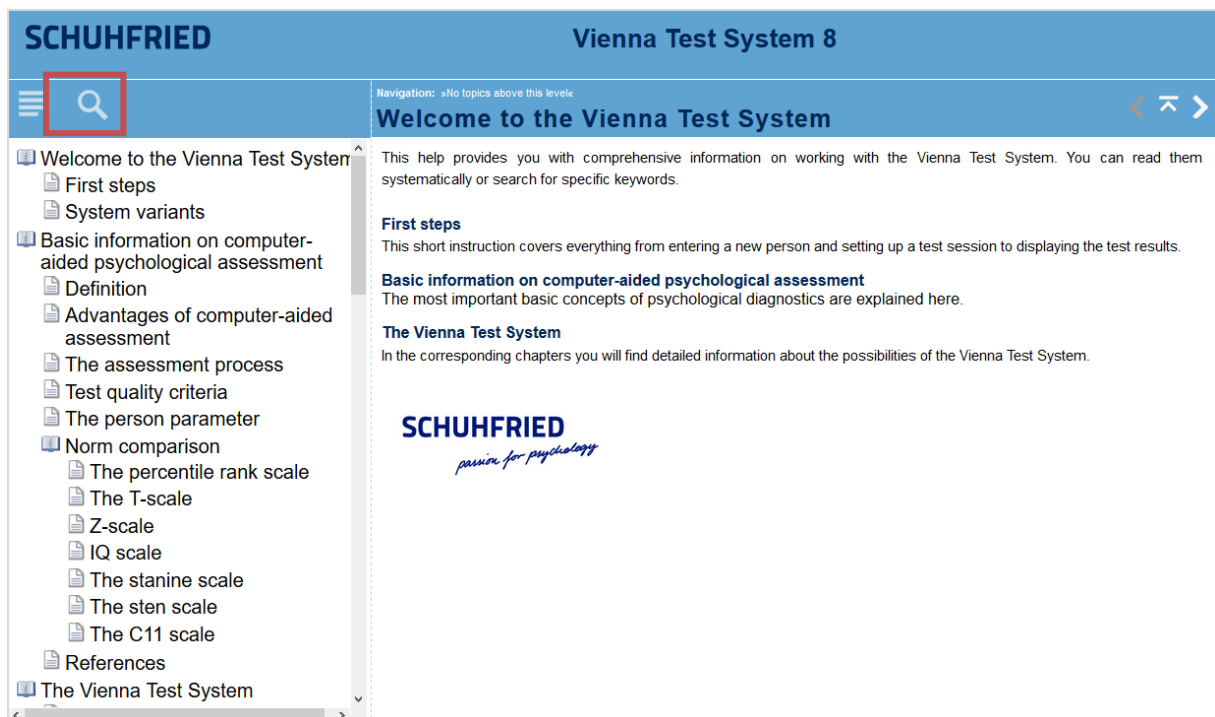

Figure 13: Help file of the Vienna Test System

To open a digital test manual, use the “Manual” button on the “Test” tab; this enables the manual for a selected test to be opened in the language of the administration window (see Figure 14).

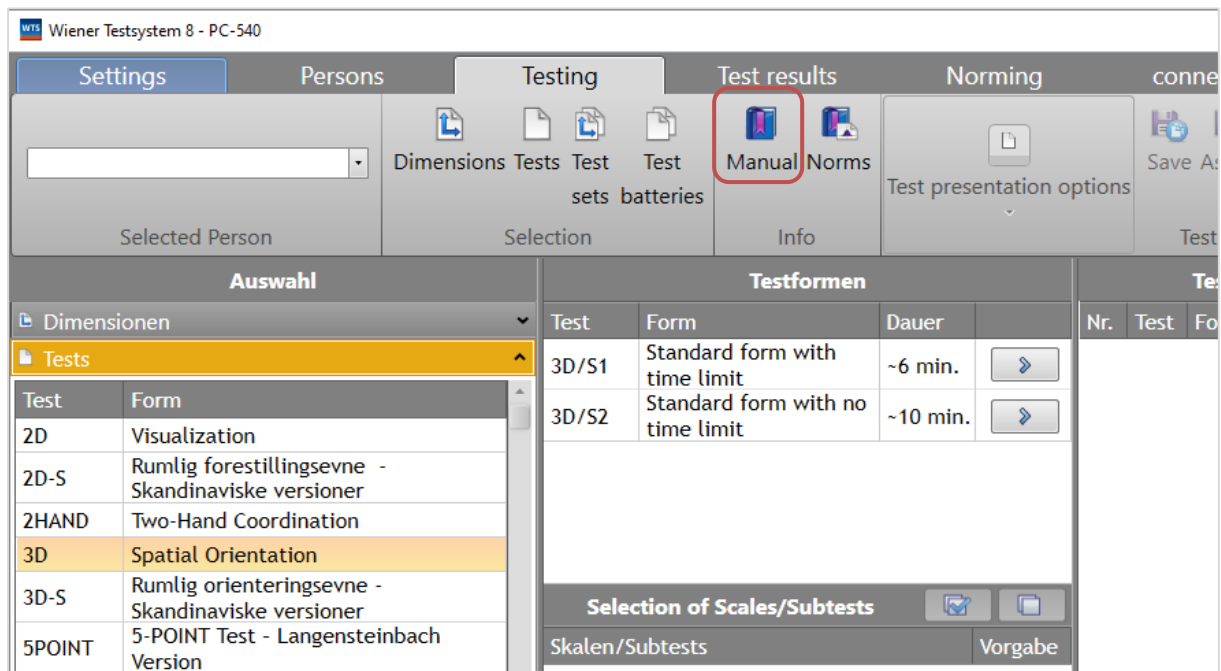

Figure 14: Selection of a digital test manual

5.2 Manuals

For a list of all test manuals in all the languages in which they are available, go to “Settings → Test administration → Administration“. Under “Open test manual” the manual can be selected in the required language (see Figure 15).

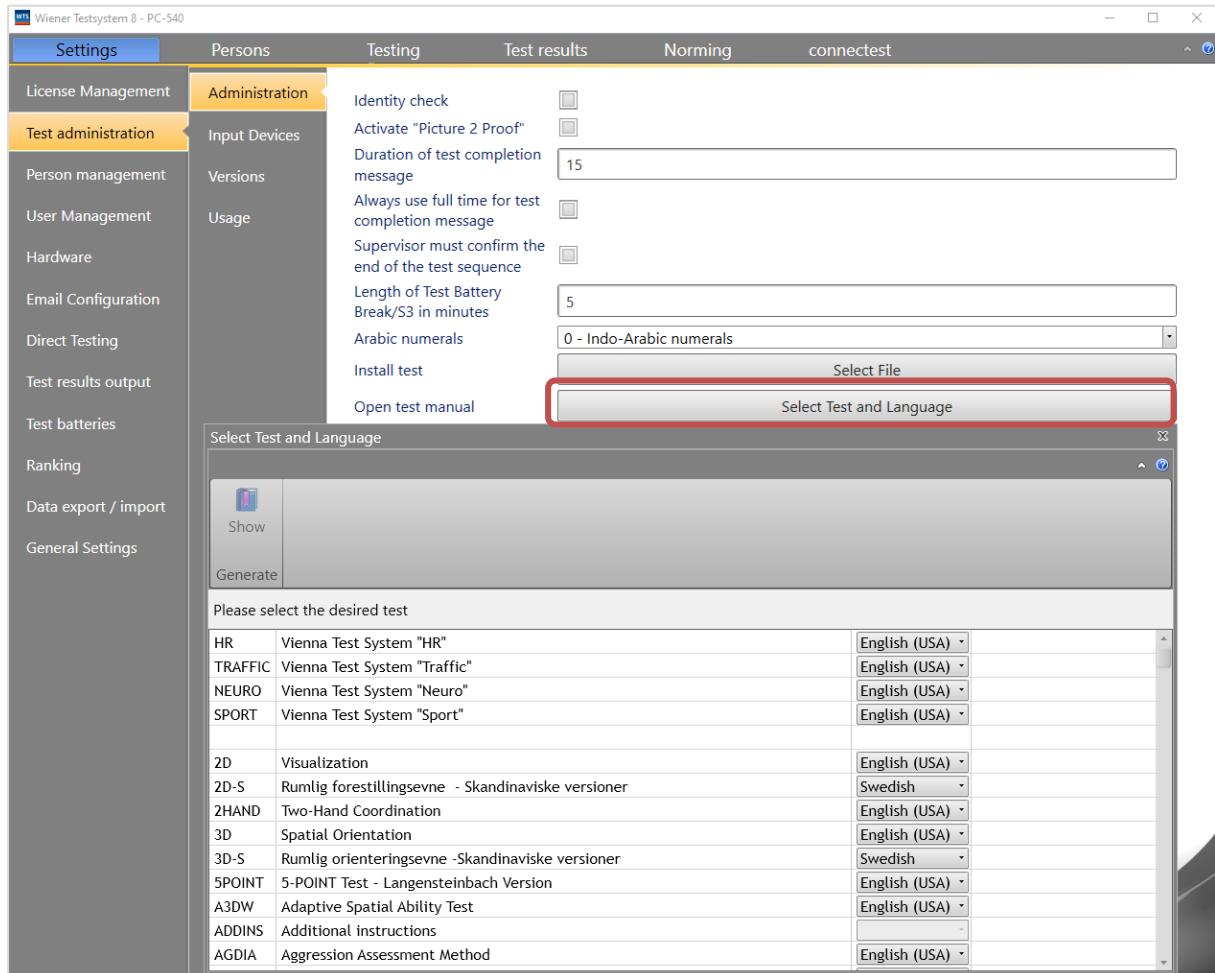

Figure 15: Call up of the test manuals in different languages

The manual for each version (HR, SPORT, TRAFFIC and NEURO) can be opened in the same window.

5.3 Customer service

We take customer service seriously. We therefore offer the best possible support in all areas:

- **Support:**
For technical queries or problems please contact our HelpDesk.
- **Specialist psychological advice**
Our team of experienced psychologists is always happy to answer any questions.
- **Product information**
Our advisers are happy to provide information on all our products.

Austria: +43 2236 42315-0

info@schuhfried.com

www.schuhfried.com

5.3.1 Troubleshooting

If a device fails to work, the following procedures may identify and correct the fault:

- Unplug the device and plug it back in again
- Re-start Windows
- Connect the device to a different USB port (the device driver may need to be re-installed)
- Unplug other USB devices
- Connect the device direct to the computer, without a USB hub

The functioning of your devices can be tested with the Vienna Test System as follows:

Start the Hardware Test by clicking the button under “Settings → Hardware → Hardware test“. The first window (see Figure 16) displays a list of all the connected devices.

Device	Status	Notes
Light Pen	No	Device not connected
Response Panel	Yes	
Analog input devices	Yes	
Monitor calibration	No	Device not connected
Tone generator	Yes	
Sound card	Yes	
Microphone	No	
MLS Work Panel (basic test)	No	Device not connected
MLS Work Panel (aiming test)	No	Device not connected
Flicker Fusion Unit	No	Device not connected
Peripheral Perception Unit	No	Device not connected
CPU-availability	No	

Figure 16: Connected devices of the Vienna Test System

**If you cannot solve the problem,
please contact Product Support at SCHUHFRIED GmbH.**

E-mail: support@schuhfried.com
Telephone: + 43 2236 42315-460
Fax: + 43 2236 46597

5.4 Hardware Test

The hardware test respectively the calibration of the screen can be started at **Settings** → **Hardware**:

- Click the button “Start” next to “**Hardware Test**” to check on of the following devices:
 - Response panel
 - Foot pedals
 - Analog foot pedals
 - MLS work panel
 - Flicker fusion unit
 - Peripheral perception (PP-HW – with serial connection and a massive aluminum ground plate)

- Click the button “Start” next to “PP-R Hardware Test” to check the Peripheral perception unit PP-HW2 (USB-connection).

- Click “Start” next to “Calibration of touch screen entry” to calibrate the response time of a touch interface.

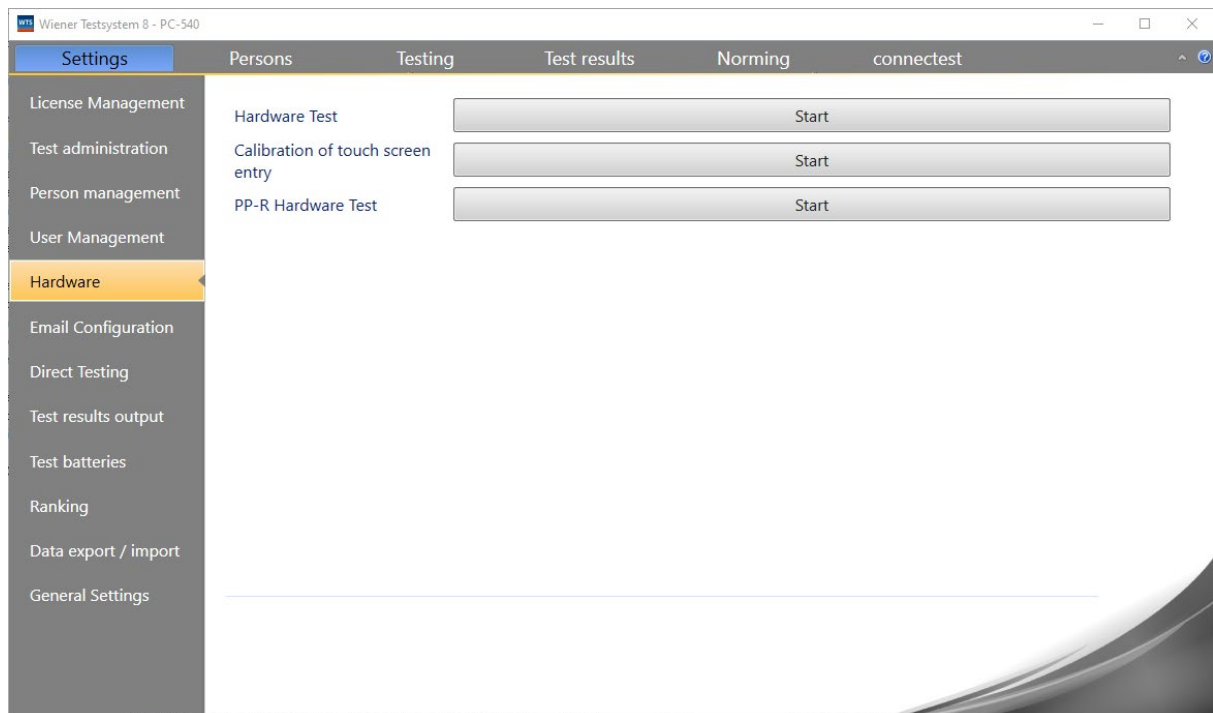

Figure 17: Hardwaretest

5.4.1 Hardware Test

Use the Hardware test to check the functional suitability of the peripheral devices of the Vienna Test system after completing the installation.

It is recommended to perform the hardware test quarterly or half-yearly, dependent on your quality management system. Perform the test after each change of the system configuration. Finally a report can be print out as confirmation.

A window is shown at the beginning in where you can check which devices are connected. Check if all connected devices are set to "Yes".

The Hardware test starts with the first device, after clicking "Ok". Please consider, that the foot pedals are checked as part of the panel. The analog foot pedals are checked as part of the "Analog input devices".

Device	Selection	Status
Light Pen	No	Device not connected
Response Panel	Yes	
Analog input devices	Yes	
Monitor calibration	No	Device not connected
Tone generator	Yes	
Sound card	Yes	
Microphone	No	
MLS Work Panel (basic test)	No	Device not connected
MLS Work Panel (aiming test)	No	Device not connected
Flicker Fusion Unit	No	Device not connected
Peripheral Perception Unit	No	Device not connected
CPU-availability	No	

Figure 18: Introduction of the Hardware test

The program guides you through the checking of all devices. Perform all stated steps.

Example of the Hardware test for the response panel

1. An introduction with explanations to each test is presented at the beginning. Click "Start Test" to start the check. Click "Next test" if you want to skip this test.
2. You are asked to press the respective key. Proceed with the keys which are shown. Press "Next Key" if a key doesn't work to finish the test. Keys which were not pressed are recorded in the report.
3. You can finish the test with "Conclude Test" if the test was performed completely. The test for the next hardware will start automatically (Figure 18).

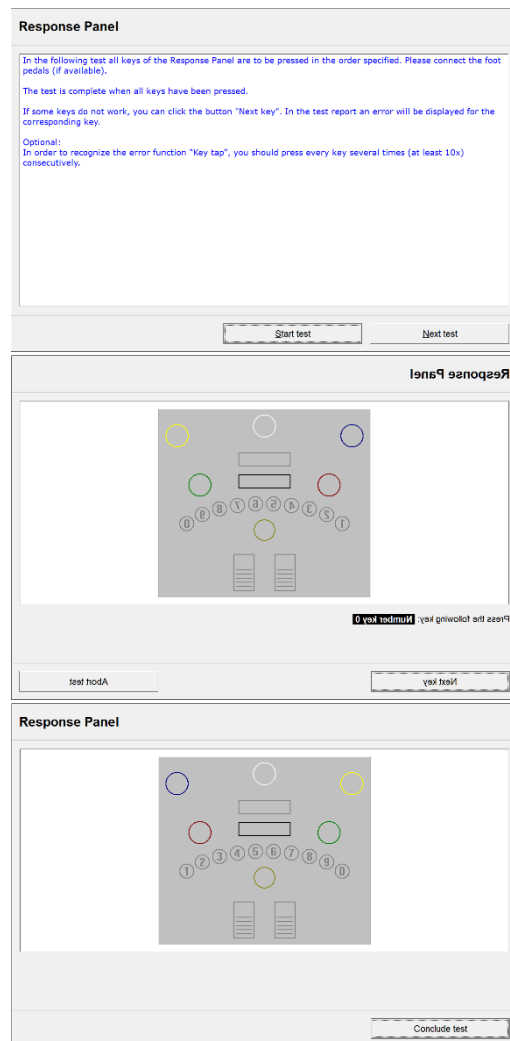

CPU-availability

The test "CPU-availability" should be used to check if background processes influence the Vienna Test system.

Perform the test at least for five minutes and stop it with ESC. Prolong the test if there interruptions are occur.

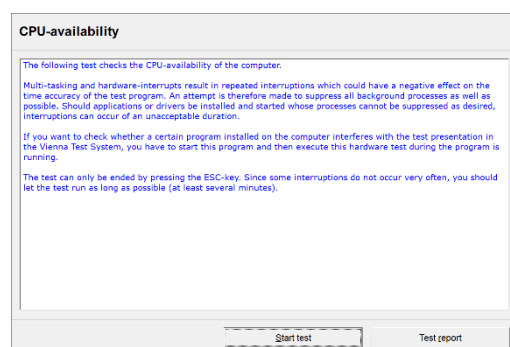

5.4.2 Calibration of the Touch-Input

You need a calibration module of SCHUHFRIED for the calibration. Connect the module at a free USB-socket of your computer.

The calibration of the touch input is necessary if use this input for visual stimuli in combination with time critical tests. If you use the speakers of the PC⁵ for acoustic stimuli in combination with a touchscreen you have to calibrate the speaker as well. Choose, if you want to calibrate the visual Touch-input or the Touch-input in combination with acoustic stimuli (see Figure 19).

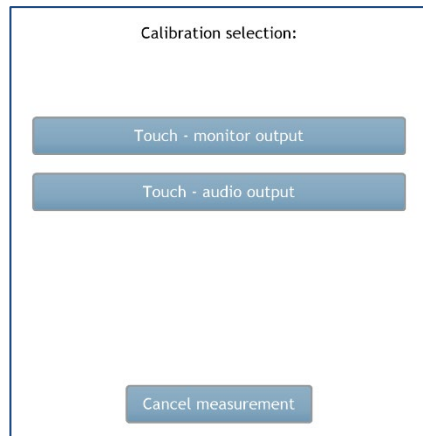

Figure 19: Selection of the calibration type

An instruction concerning the connection of the calibration unit (Figure 20) is presented after the selection. The completion of the calibration is shown on the screen, see Figure 21.

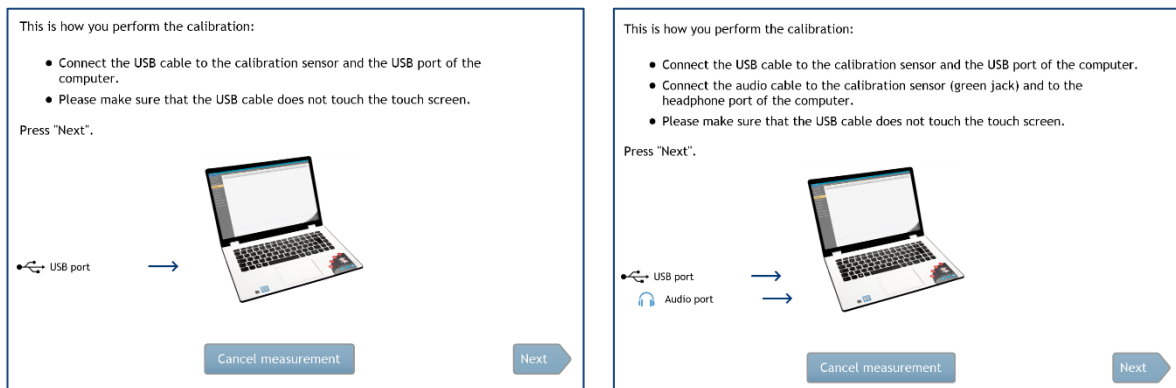

Figure 20: Start page for the visual touch calibration (left) and the auditive touch calibration (right)

⁵ This is **not necessary** if you use an USB audio device!

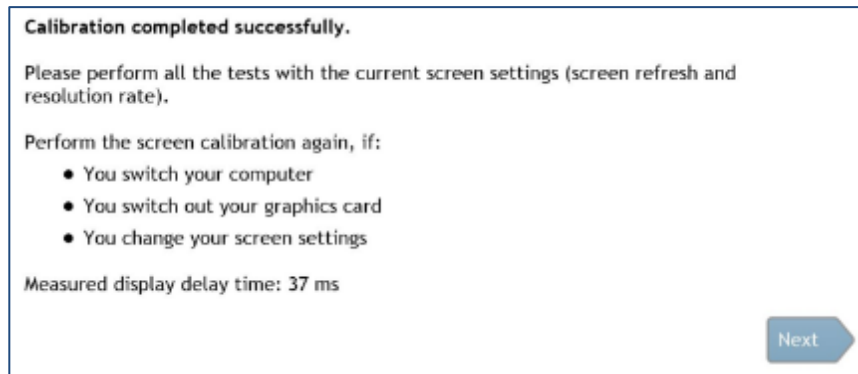

Figure 21: Confirmation of the calibration

5.4.3 Hardware test of PP-HW2

Please enter the HW-serial number⁶ and the person which performs the test at the beginning of the test (see Figure 22). Perform the test step by step (see Figure 23) and confirm with “OK” (the button is blue colored)

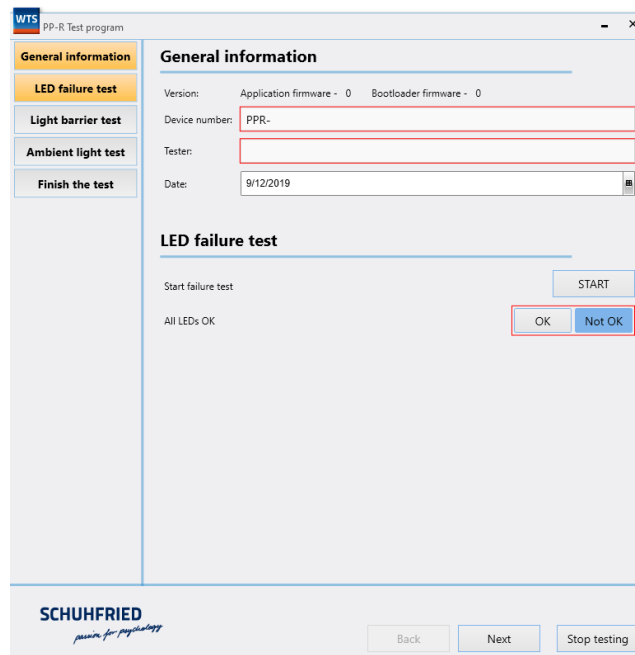

Figure 22: First step of the hardware test for PP-HW2

⁶ The serial number can be found at the label of the back side of the LED-panels.

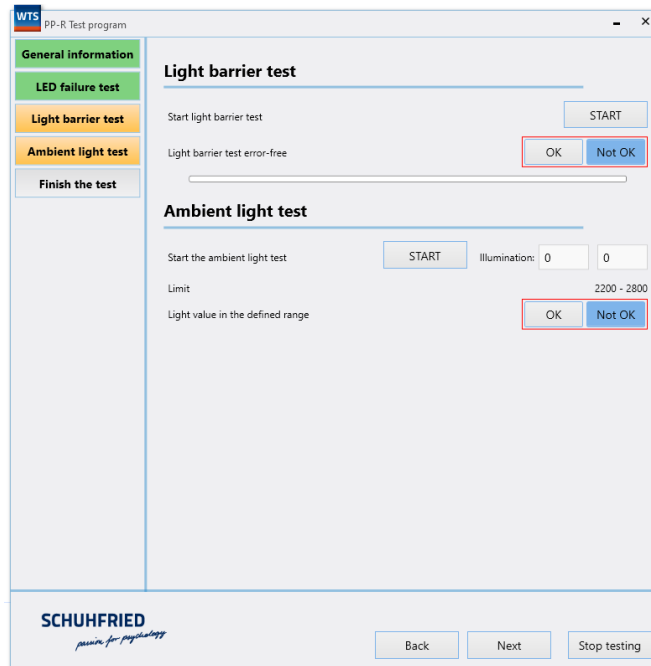









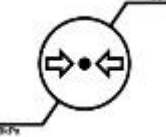

Figure 23: Step two and three of the test

A report can be printed out at the end of the test.

6 ADDITIONAL INFORMATION

6.1 Warnings

	<p>This symbol means: Caution, the hardware manual must be read before operation</p>
	<p>Symbol for the manufacturing date. The year in which the device was produced is shown next to the symbol.</p>
	<p>Symbol for the serial number of the device: The serial number of the devices is next to this symbol</p>
	<p>The product must be disposed of with certain waste material collection points or recycling centers or via the manufacturer.</p>
	<p>Symbol for the manufacturer. The manufacturer is provided next to this symbol.</p>
	<p>Symbol for a device of the protection class 2 according to IEC 60417-4172</p>
	<p>Symbol for the designation of the device. The designation stands next to the symbol.</p>
	<p>This symbol specifies the permissible temperature range.</p>
	<p>This symbol specifies the permissible humidity for the storage.</p>
	<p>This symbol specifies the permissible atmospheric pressure for the storage.</p>

6.2 Device maintenance

All Vienna Test System devices are maintenance-free. However, the Vienna Test System's hardware test should be used every six months to check that the devices are functioning properly.

Maintenance, repairs and alterations must be carried out in accordance with the Electrotechnical Act.

Alterations and repairs carried out by unauthorized individuals or companies invalidate the manufacturer's warranty and product liability.

The devices must always be switched off before cleaning. Use only disinfectants, or mild detergents, to clean the equipment with a soft cleaning cloth. Avoid applying cleaning or disinfecting agents directly to the unit and its parts to prevent liquid from penetrating the enclosure.

Surface disinfectants are basically suitable as cleaning or disinfecting agents. If the devices are used in health care facilities, agents should be used which are approved for medical products according to the Medical Devices Act and Directive 93/42/EEC. Permissible are liquids based on alcohol (ethanol) or on active ingredients of active oxygen, which do not contain solvents and do not scrub (e.g. Schülke mikrozyd AF liquid or ANTISEPTICA Descogen Liquid r.f.u.).

After cleaning the device, wait a few minutes before using it again. This makes it possible for any residues of cleaning or disinfecting agents to evaporate.

The product life provided by the manufacturer is 10 years from the date of manufacture. This date can be found on the nameplate.

6.3 Safety information

Although the devices are not medical devices, they have been developed in accordance with the requirements of the ÖVE standard EN 60601, but only comply with these requirements if they are connected to a computer system that also fulfills these requirements.

Place the cables in such a way that the devices cannot be unintentionally pulled down or left hanging. Loose cables should not be left lying near the client, but there should be sufficient spare cable for the client to be able to adjust the devices he needs to use.

When using headphones, make sure that the volume is not too high when the subject puts on the headphones to prevent damage to their hearing.

Do not use a peripheral device if parts are damaged or broken off.

The USB peripheral devices of the Vienna Test System must not be used in damp areas or places where there is a risk of explosion.

The manufacturer or supplier can only be held responsible for matters affecting safety or performance of the device if

- assembly, upgrades, re-setting, alterations or repairs are carried out by persons authorized by him and
- the electrical installation at the place of use conforms to IEC or ÖVE EN 7 regulations and
- the devices are used in accordance with the instructions, and are not used at the same time as USB peripheral devices of other manufacturers.

6.3.1 Notes on EMC

If the input and output media of the Vienna Test System are used in a clinical environment, special precautions regarding EMC must be taken. Even in the non-medical environment, special care must be taken with regard to EMC. To ensure safe operation, the use of portable and mobile HF communication systems is prohibited, because they could interfere with the functioning of the system.

6.3.2 Notes on ESD

All input devices incorporate all precautions against electrostatic discharge necessary to prevent damage to components. The excess energy is discharged to earth by means of protective diodes. If an input device should crash, please go through the points in Section 5.3.1 in turn. If the device has failed during a test, the test must be repeated. Electrostatic discharge can be caused by the friction of rubber soles on carpets or synthetic flooring. Take particular care when touching electrically conductive components.

Further information on EMC-compliant maintenance and the relevant guidelines can be found in Section 6.6.

6.4 Exclusion of liability

The manufacturer or supplier can only be held responsible for matters affecting safety or performance of the device if

- assembly, upgrades, re-setting, alterations or repairs are carried out by persons authorized by him and
- the electrical installation at the place of use conforms to IEC or ÖVE EN 7 regulations and
- the devices are used in accordance with the instructions, and are not used at the same time as USB peripheral devices of other manufacturers.

6.5 Packaging and transport

The packaging is reusable and should be retained in case the equipment needs to be transported. We recommend the same conditions for transport as during storage.

The foamed plastic contained in the packaging consists of pure polyethylene (PE) and is produced without the use of CFCs.

Disposal: Recycling by a PE processor

- Leaves no residue when incinerated
- Groundwater-neutral in landfill

6.6 Guidelines and manufacturer's declaration for EMC compatible construction in health facilities

Table 1: Electromagnetic emissions

The PANEL Ag/Ug is intended for use in the electromagnetic environment specified below. The customer or the user of the PANEL Ag/Ug should assure that it is used in such an environment.		
Emissions test	Compliance	Electromagnetic environment – guidance
RF emissions CISPR 11	Group 1	The PANEL Ag/Ug uses RF energy only for its internal function. Therefore, its RF emissions are very low and are not likely to cause any interference in nearby electronic equipment.
RF emissions CISPR 11	Class B	The PANEL Ag/Ug is suitable for use in all establishments, including domestic establishments and those directly connected to the public low-voltage power supply network that supplies buildings used for domestic purposes.
Harmonic emissions IEC 61000-3-2	Not applicable	
Voltage fluctuations/flicker emissions IEC 61000-3-3	Not applicable	

Table 2: Electromagnetic immunity

The PANEL Ag/Ug is intended for use in the electromagnetic environment specified below. The customer or the user of the PANEL Ag/Ug should assure that it is used in such an environment.			
Immunity test	IEC 60601 test level	Compliance level	Guidance
Electrostatic discharge (ESD) IEC 61000-4-2	±6 kV contact ±8 kV air	±6 kV contact ±8 kV air	Floors should be wood, concrete or ceramic tile. If floors are covered with synthetic material, the relative humidity should be at least 30 %.
Electrical fast transient/burst IEC 61000-4-4	±2 kV for power supply lines ±1 kV for input/output lines	Not applicable –all electrical lines are shorter than 3m	Mains power quality should be that of a typical commercial or hospital environment.
Surge IEC 61000-4-5	± 1 kV differential mode ± 2 kV common mode	Not applicable –all electrical lines are shorter than 3m	Mains power quality should be that of a typical commercial or hospital environment.
Voltage dips, short interruptions and voltage variations on power supply input lines IEC 61000-4-11	< 5 % UT (> 95 % dip in UT) for ½ cycle 40 % UT (60 % dip in UT) for 5 cycles 70 % UT (30 % dip in UT) for 25 cycles < 5 % UT (> 95 % dip in UT) for 5 s	Not applicable – No connection to electric supply	Mains power quality should be that of a typical commercial or hospital environment. If the use of the PANEL Ag/Ug requires continued operation during power mains interrupts, it is recommended that the PANEL Ag/Ug be powered from an uninterruptible power supply or a battery.
Power frequency (50 Hz/60 Hz) magnetic field IEC 61000-4-8	3 A/m	3 A/m	Power frequency magnetic fields should be at levels characteristic of a typical location in a typical commercial or hospital environment.
Note	U _T is the a.c. mains voltage prior to application of the test level.		

Table 3: Electromagnetic immunity

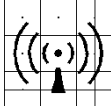
The PANEL Ag/Ug is intended for use in the electromagnetic environment specified below. The customer or the user of the PANEL Ag/Ug should assure that it is used in such an environment.			
Immunity test	IEC 60601 test level	Compliance level	Electromagnetic environment - guidance
			Portable and mobile RF communications equipment should be used no closer to any part of the PANEL Ag/Ug , including cables, than the recommended separation distance calculated from the equation applicable to the frequency of the transmitter. Recommended separation distance:
Conducted RF IEC 61000-4-6	3 V _{eff} 150 kHz to 80 MHz	3 → V ₁ in V	$d = \left(\frac{3,5}{V_1} \right) * \sqrt{P}$
Radiated RF IEC 61000-4-3	3 V/m 80 MHz to 2,5 GHz	3 → E ₁ in V/m	$d = \left(\frac{3,5}{E_1} \right) * \sqrt{P}$ 80 MHz to 800 MHz
			$d = \left(\frac{7}{E_1} \right) * \sqrt{P}$ 800 MHz to 2,5 GHz
			Where P is the maximum output power rating of the transmitter in watts (W) according to the transmitter manufacturer and d is the recommended separation distance in metres (m).b
			Field strengths from fixed RF transmitters, as determined by an electromagnetic site survey,a should be less than the compliance level in each frequency range.b Interference may occur in the vicinity of equipment marked with the following symbol: 
Note 1	At 80 MHz and 800 MHz, the higher frequency range applies.		
Note 2	These guidelines may not apply in all situations. Electromagnetic propagation is affected by absorption and reflection from structures, objects and people.		
a	A Field strengths from fixed transmitters, such as base stations for radio (cellular /cordless) telephones and land mobile radios, amateur radio, AM and FM radio broadcast and TV broadcast cannot be predicted theoretically with accuracy. To assess the electromagnetic environment due to fixed RF transmitters, an electromagnetic site survey should be considered. If the measured field strength in the location in which the PANEL Ag/Ug is used exceeds the applicable RF compliance level above, the PANEL Ag/Ug should be observed to verify normal operation. If abnormal performance is observed, additional measures may be necessary, such as reorienting or relocation the PANEL Ag/Ug.		
b	Over the frequency range 150 kHz to 80 MHz, field strengths should be less than [V1] V/m.		

Table 4: Recommended safety distances

Recommended safety distances between portable and mobile HF telecommunication devices and the radio modules			
The PANEL Ag/Ug are intended for use in an electromagnetic environment in which HF disturbances are monitored. The client or user of the PANEL Ag/Ug can help to avoid electromagnetic interference by observing the minimum distances between portable or mobile HF telecommunication devices (transmitters) and the PANEL Ag/Ug – depending on the output of the communication device – as given below.			
<u>Nominal output of the transmitter</u> W	<u>Safety distance depending on transmitter frequency</u> m		
	150 kHz to 80 MHz	80 MHz to 800 MHz	800 MHz to 2.5 GHz
	$d = \left(\frac{3,5}{V1}\right) * \sqrt{P}$	$d = \left(\frac{3,5}{E1}\right) * \sqrt{P}$	$d = \left(\frac{7}{E1}\right) * \sqrt{P}$
0.01	0.12	0.12	0.23
0.1	0.37	0.37	0.74
1	1.17	1.17	2.33
10	3.69	3.69	7.38
100	11.67	11.67	23.33
If the maximum nominal output of the transmitter is not shown in the above table, the distance can be calculated by using the formula in the relevant column, where P is the maximum nominal output of the transmitter in watts as stated by the manufacturer of the transmitter.			
Note 1	At 80 MHz and 800 MHz the higher frequency range applies.		
Note 2	These guidelines may not be applicable in all cases. The propagation of electromagnetic fields is affected by the absorption and reflection of buildings, objects and people.		